

VALUE[®]

Making Your Job More Enjoyable

2023 VALUE V1.0



VALUE[®]

VALUE Mechanical & Electrical Products CO., LTD

Add: No. 5 Third Street, East Industrial Park, Wenling, Zhejiang, China

Tel: +86-576-86191959

Fax: +86-576-86191957

Email: value@worldvalue.cn

www.worldvalue.cn



Making Your Job More Enjoyable



MISSION OF VALUE ——VALUE CREATES VALUE

Empower smart work,
Forge bright future,
VALUE creates value!



We provide our customers with innovative and qualitative solutions of refrigeration tools and vacuum systems to help them succeed, and to advance technologies.

WHO IS VALUE

VALUE is the leader of global air conditioner refrigeration tools dedicated to refrigeration tools and vacuum solutions. Over the past 20 years, the Company has kept technological innovation, and explored cutting-edge technologies concerning air conditioner refrigeration tools with the purpose of offering innovative and quality products, services and system solutions to users, and helping customers complete tasks in a more easier way.

The annual production capacity is 600,000 for rotary-vane vacuum pumps and 80,000 recovery unit. Right now, Value has become the largest manufacturer of refrigeration vacuum pump, recovery unit and tools in the world.

Global leader

in refrigeration tools and vacuum solutions

VISION OF VALUE

To be the leader in solutions of refrigeration tools and vacuum system.

- Global Market
- Leading Technology
- One of the best

DEVELOPMENT HISTORY



Welcome to VALUE

Global leader of refrigeration tools and vacuum solutions

ABOUT US

VALUE is the global leader of refrigeration tools and vacuum solutions. After 20 years of historical accumulation, the three core competencies which are continuous technological innovation capabilities, social resource integration capabilities and brand channels all over the world, have made the company keep its leadership in the global refrigeration industry.

VALUE has accumulated the industry's veteran expert teams with experienced, we are always working on innovative work unswervingly to develop the best products, which can provide personalized design and service in the shortest time to meet customer needs. We have built a global innovation and Technology Research Institute, a huge proportion of R & D funds is invested every year, innovative development of the industry's leading products; the quality of our products reaches the world first-class level, through the CE, UL, CSA and other security certification and ISO9001:2015 quality management system certification, and we also have built product failure analysis laboratory, thermostat and constant humidity production workshop and product prototype test center. We have introduced a lot of high precision manufacturing technology and equipment, Japanese Multi-Tasking machining center, Japanese SEIKI horizontal machining center and OKUMA vertical machining center, Germany WENZEL three coordinate measuring instrument and other modern machining and testing equipment, the full implementation of the ERP data management and lean production management system.

Through years of development, we have our owned global brand and channels. It has built "VALUE" independent brand sales channels in more than 90 countries, and has provided services for more than 10 of world top 500 enterprises.

"speed, innovation, high quality", create value for customers

Core competitiveness
Speed • Innovation • High quality



Wenling production base



Global institute of innovation technology of VALUE in Hangzhou



High quality manufacturing

VALUE is fully equipped with modernized processing and testing instruments, such as Japanese Multi-Tasking machining center, Japanese DMG Mori Seiki horizontal machining center, Japanese OKUMA- BYJC vertical machining center, German WENZEL three coordinates measuring equipment, etc. We carry out ERP data management and lean production management system.

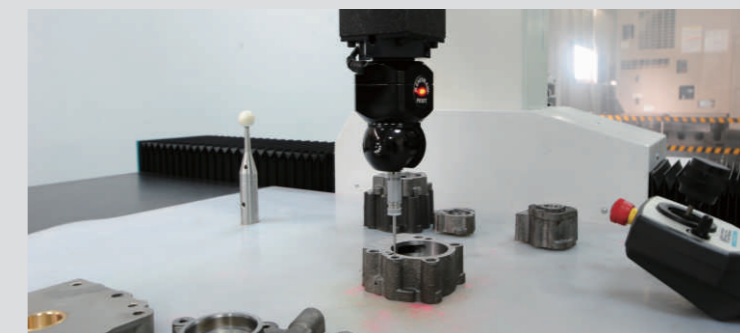

Precision measure industry benchmark

Our products are qualified with world's most advanced quality level. We have European CE, American UL, Canada CSA safety certificates and German TUV ISO9001: 2015 certificate. And we also own product failure analysis lab, the constant temperature and humid workshop, new product trial center.

GLOBAL BRAND CHANNELS

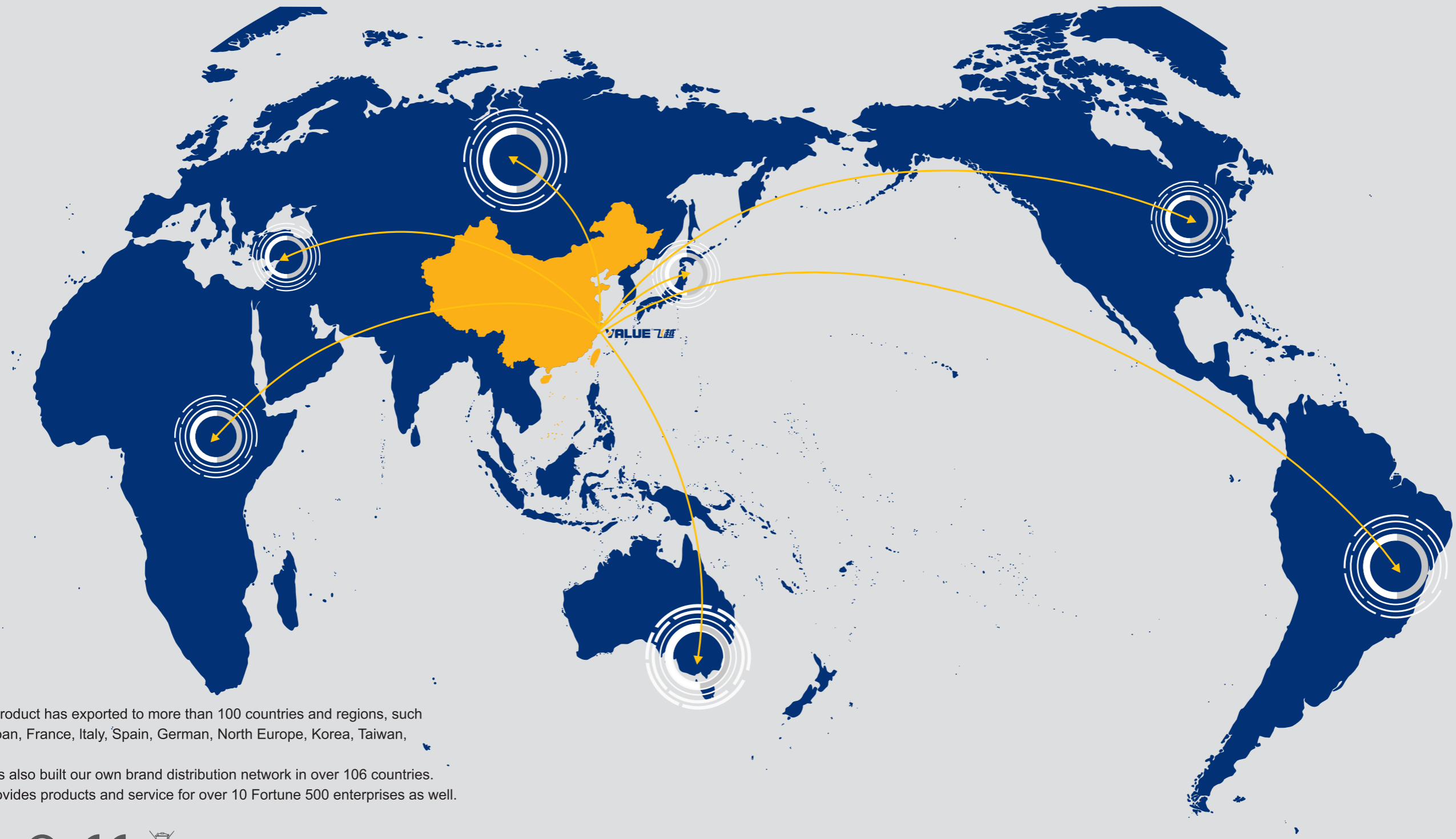

VALUE's product has exported to more than 100 countries and regions, such as US, Japan, France, Italy, Spain, German, North Europe, Korea, Taiwan, Brazil, etc.
VALUE has also built our own brand distribution network in over 106 countries.
VALUE provides products and service for over 10 Fortune 500 enterprises as well.



CLASSIC SERIES OF VALUE



"Creating value for customers" is the core mission of VALUE. VALUE Helps customers to accomplish work easier, efficiently and with high quality. We continue to study the working process of the user's pain point, experience the user's experience, we developed high reliability series vacuum pump, light / fast series recovery machine, enjoyable series pipe tools and precision measuring instrument series, provides a full range of high-quality refrigeration maintenance tools for customers, help customers more easily complete maintenance work of air conditioning products.

VALUE's Classic series to provide customers with a high quality full range of refrigeration maintenance tools.

Leading Technology, Superior Quality, Best Experience.

Making your job more enjoyable

CONTENTS

Classic Series of VALUE

Vacuum pump

N Series Vacuum Pump	03
i Series New Refrigerant Vacuum Pump	05
R32 Series Vacuum Pump	06
Vacuum Pump Oil	08
Vacuum Pump Selection	09
Power Series Vacuum Pump	11



Recovery machine

M Series Recovery Unit	15
L Series Recovery Unit	17



Refrigeration tools

Manifold Gauge	23
Single Gauge	27
Pressure Gauge	28
Digital Manifold Gauge	31
Quick Coupler	35
Refrigeration hoses	36
Valve Core Removal Tool	38
Valve Opener	39
Check Valve	40
Refrigerant Scale	41



Pipe tools/HVAC instrument

Pipe tools	
> Cordless Flaring Tool	45
> Flaring Tool	47
> Power Tube Tool	51
> Bending Tool	53
> Power Tube Expander	55
> Hydraulic Tube Expander	56
> Tube Expander	57
> Tube Cutter	58
> Integrated Tool	59
> Tool Kit	61
HVAC instrument	
Condensate Pump	69



NAVTEK™

High-end Series

Ushering in the smart era of HVAC tools

Vacuum Pump	73
Recovery Unit	79
Leak Detector	81
Manifold Gauge	83
Wireless Refrigerant Scale	87



Vacuum Pump

High · Reliable

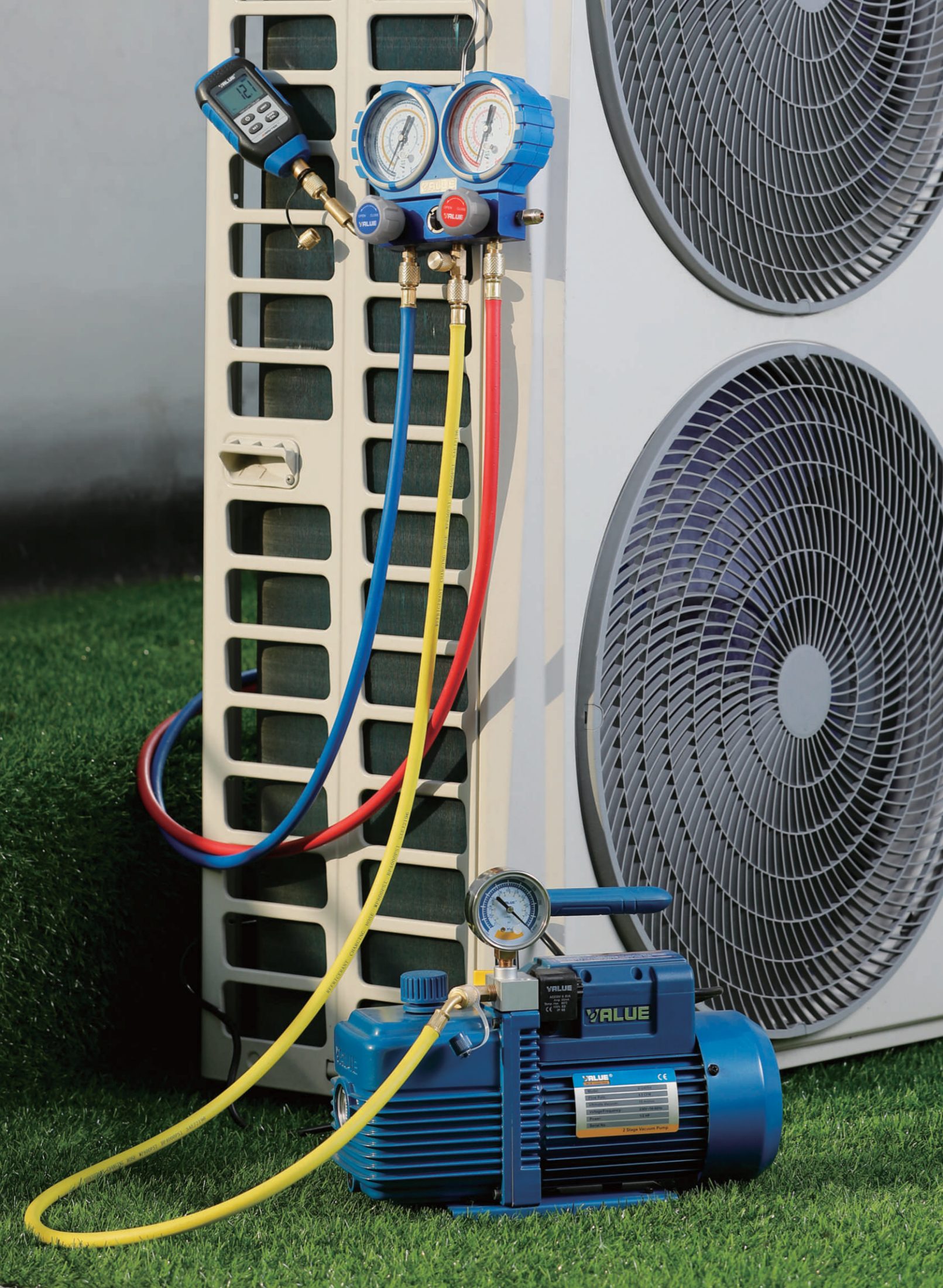
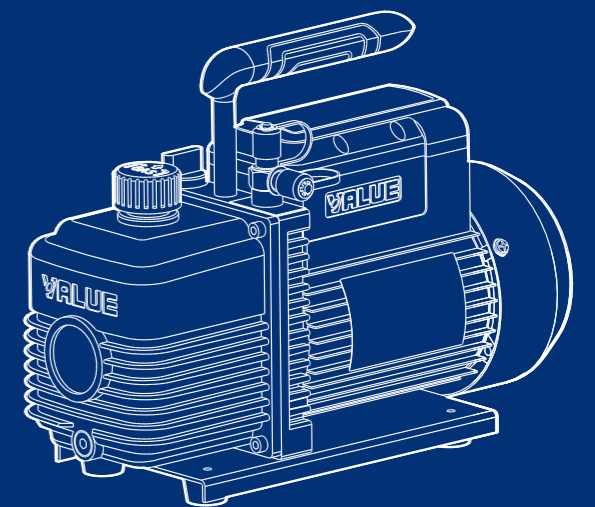

N Series Vacuum Pump

Suitable for R407C, R404A, R507A, R134a refrigerant



N Series Vacuum Pump

Suitable for R407C, R404A, R507A, R134a refrigerant



High Reliability

Integrated Body Structure

- Higher precision
- Higher ultimate vacuum

Forced Oil Cycling System

- High reliability

Large Oil Screen

- Better visibility

Single Stage

Model		VE115N	VE125N	VE135N	VE160N	VE180N
Flow Rate	50Hz	1.8 CFM 51 L/min	2.5 CFM 70 L/min	3.5 CFM 100 L/min	6.0 CFM 170 L/min	8.0 CFM 226 L/min
	60Hz	2.0 CFM 57 L/min	3.0 CFM 84 L/min	4.0 CFM 113 L/min	7.0 CFM 198 L/min	9.0 CFM 254 L/min
Ultimate Vacuum	Partial Pressure	2 Pa	2 Pa	2 Pa	2 Pa	2 Pa
	Total Pressure	150 micron	150 micron	150 micron	150 micron	150 micron
Power		1/4 HP	1/4 HP	1/3 HP	1/2 HP	3/4 HP
Inlet Port		1/4" SAE	1/4" SAE	1/4" & 3/8" SAE	1/4" & 3/8" SAE	1/4" & 3/8" SAE
Oil Capacity		250 ml	250 ml	250 ml	415 ml	660 ml
Dimensions		290x124x224 mm	290x124x224 mm	318x124x234 mm	338x138x244 mm	395x145x257 mm
Weight		6.6 kg	7.1 kg	8.0 kg	9.9 kg	14.6 kg

Dual Stage

Model		VE215N	VE225N	VE245N	VE260N	VE280N	VE2100N
Flow Rate	50Hz	1.5 CFM 42 L/min	2.5 CFM 70 L/min	4.5 CFM 128 L/min	6.0 CFM 170 L/min	8.0 CFM 226 L/min	10.0 CFM 283 L/min
	60Hz	1.8 CFM 50 L/min	3.0 CFM 84 L/min	5.0 CFM 142 L/min	7.0 CFM 198 L/min	9.0 CFM 254 L/min	12.0 CFM 340 L/min
Ultimate Vacuum	Partial Pressure	2x10 ⁻¹ Pa	2x10 ⁻¹ Pa	2x10 ⁻¹ Pa	2x10 ⁻¹ Pa	2x10 ⁻¹ Pa	2x10 ⁻¹ Pa
	Total Pressure	15 micron	15 micron	15 micron	15 micron	15 micron	15 micron
Power		1/4 HP	1/3 HP	1/2 HP	3/4 HP	1 HP	1 HP
Inlet Port		1/4" SAE	1/4" SAE	1/4" & 3/8" SAE	1/4" & 3/8" SAE	1/4" & 3/8" SAE	1/4" & 3/8" SAE
Oil Capacity		200 ml	200 ml	325 ml	580 ml	500 ml	590 ml
Dimensions		308x124x224 mm	318x124x234 mm	338x138x244 mm	395x145x257 mm	395x145x257 mm	395x145x257 mm
Weight		7.5 kg	8.5 kg	10.4 kg	15.8 kg	16.2 kg	16.7 kg

High Reliability

Integrated Body Structure

- Higher precision
- Higher ultimate vacuum

Forced Oil Cycling System

- High reliability

Large Oil Screen

- Better visibility

Dual Stage

Model		VE215ND	VE225ND	VE245ND
Flow Rate	50Hz	1.5 CFM 42 L/min	2.5 CFM 70 L/min	4.5 CFM 128 L/min
	60Hz	1.8 CFM 50 L/min	3.0 CFM 84 L/min	5.0 CFM 142 L/min
Ultimate Vacuum	Partial Pressure	2x10 ⁻¹ Pa	2x10 ⁻¹ Pa	2x10 ⁻¹ Pa
	Total Pressure	15 micron	15 micron	15 micron
Power		1/4 HP	1/3 HP	1/2 HP
Inlet Port		1/4" SAE	1/4" SAE	1/4" & 3/8" SAE
Oil Capacity		200 ml	200 ml	325 ml
Dimensions		318x124x234 mm	318x124x234 mm	338x138x244 mm
Weight		8.5 kg	8.5 kg	10.4 kg

Model		VE260ND	VE280ND	VE2100ND
Flow Rate	50Hz	6.0 CFM 170 L/min	8.0 CFM 226 L/min	10.0 CFM 283 L/min
	60Hz	7.0 CFM 198 L/min	9.0 CFM 254 L/min	12.0 CFM 340 L/min
Ultimate Vacuum	Partial Pressure	2x10 ⁻¹ Pa	2x10 ⁻¹ Pa	2x10 ⁻¹ Pa
	Total Pressure	15 micron	15 micron	15 micron
Power		3/4 HP	1 HP	1 HP
Inlet Port		1/4" & 3/8" SAE	1/4" & 3/8" SAE	1/4" & 3/8" SAE
Oil Capacity		580 ml	500 ml	590 ml
Dimensions		395x145x257 mm	395x145x257 mm	395x145x257 mm
Weight		15.8 kg	16.2 kg	16.7 kg

I Series New Refrigerant Vacuum Pump

Suitable for R410A, R407c, R134a, R12, R22 refrigerant

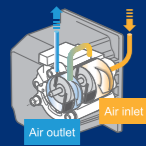

Integrated body structure
Higher precision
Higher ultimate vacuum

Large oil screen Better visibility



High precision vacuum gauge

Solenoid valve

Suit for
R32

R32 Series Vacuum Pump

Suitable for R32, 1234yf refrigerant

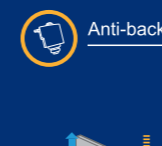

Anti-backflow solenoid valve

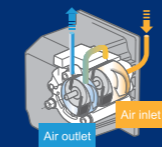

Integrated body structure
Higher precision
Higher ultimate vacuum



Electronic starter

Built-in vacuum gauge



Electronic starter,
closed switch to make the
system explosion-proof

High Reliability

Integrated Body Structure

- Higher precision
- Higher ultimate vacuum

High Precision Vacuum Gauge

- More precise

Solenoid Valve

- Absolutely prevent backflow

Large Oil Screen

- Better visibility

Single Stage

Model	V-i120SV	V-i140SV	V-i160SV	V-i180SV
Flow Rate	50Hz	1.8 CFM 51 L/min	3.5 CFM 100 L/min	5.0 CFM 142 L/min
	60Hz	2.0 CFM 57 L/min	4.0 CFM 113 L/min	6.0 CFM 170 L/min
Ultimate Vacuum	Partial Pressure	2 Pa	2 Pa	2 Pa
	Total Pressure	150 micron	150 micron	150 micron
Power	1/4 HP	1/3 HP	1/2 HP	3/4 HP
Inlet Port	1/4" SAE	1/4" SAE	1/4" SAE	1/4" SAE
Oil Capacity	250 ml	250 ml	415 ml	660 ml
Dimensions	290x124x255 mm	318x124x265 mm	338x138x275 mm	395x145x318 mm
Weight	6.7 kg	8.6 kg	10.3 kg	15.4 kg

Dual Stage

Model	V-i220SV	V-i240SV	V-i260SV	V-i280SV
Flow Rate	50Hz	1.8 CFM 51 L/min	3.5 CFM 100 L/min	5.0 CFM 142 L/min
	60Hz	2.0 CFM 57 L/min	4.0 CFM 113 L/min	6.0 CFM 170 L/min
Ultimate Vacuum	Partial Pressure	2x10 ⁻¹ Pa	2x10 ⁻¹ Pa	2x10 ⁻¹ Pa
	Total Pressure	15 micron	15 micron	15 micron
Power	1/3 HP	1/2 HP	3/4 HP	1 HP
Inlet Port	1/4" SAE	1/4" SAE	1/4" SAE	1/4" SAE
Oil Capacity	200 ml	325 ml	580 ml	500 ml
Dimensions	318x124x265 mm	338x138x275 mm	395x145x318 mm	395x145x318 mm
Weight	9.0 kg	11.0 kg	16.6 kg	17.0 kg

High Reliability

Electronic Starter • Enclosed Switch

- Explosion-proof design

Anti-backflow Solenoid Valve

- Preventing pump oil backflow from contaminating the vacuum system

Built-in Vacuum Gauge

- Built-in vacuum gauge prevents damage by impact

Integrated Body Structure

- Higher precision
- Higher ultimate vacuum

Large Oil Screen

- Better visibility

Single Stage

Model	V-i120-R32	V-i125-R32	V-i140-R32	V-i160-R32	V-i180-R32
Flow Rate	50Hz	1.8 CFM 51 L/min	2.5 CFM 70 L/min	3.5 CFM 100 L/min	5.0 CFM 142 L/min
	60Hz	2.0 CFM 57 L/min	3.0 CFM 84 L/min	4.0 CFM 113 L/min	6.0 CFM 170 L/min
Ultimate Vacuum	Partial Pressure	2 Pa	2 Pa	2 Pa	2 Pa
	Total Pressure	150 micron	150 micron	15micron	150 micron
Power	1/4 HP	1/4 HP	1/3 HP	1/2 HP	3/4 HP
Inlet Port	1/4" SAE	1/4" SAE	1/4" SAE	1/4" SAE	1/4" SAE
Oil Capacity	250 ml	250 ml	250 ml	415 ml	660 ml
Dimensions	290x124x223 mm	290x124x223 mm	318x124x237 mm	338x138x249 mm	395x145x262 mm
Weight	6.7 kg	7.2 kg	8.6 kg	10.3 kg	15.4 kg

Dual Stage

Model	V-i220-R32	V-i240-R32	V-i260-R32	V-i280-R32
Flow Rate	50Hz	1.8 CFM 51 L/min	3.5 CFM 100 L/min	5.0 CFM 142 L/min
	60Hz	2.0 CFM 57 L/min	4.0 CFM 113 L/min	6.0 CFM 170 L/min
Ultimate Vacuum	Partial Pressure	2x10 ⁻¹ Pa	2x10 ⁻¹ Pa	2x10 ⁻¹ Pa
	Total Pressure	15 micron	15 micron	15 micron
Power	1/3 HP	1/2 HP	3/4 HP	1 HP
Inlet Port	1/4" SAE	1/4" SAE	1/4" SAE	1/4" SAE
Oil Capacity	200 ml	325 ml	580 ml	500 ml
Dimensions	318x124x237 mm	338x138x249 mm	395x145x262 mm	395x145x262 mm
Weight	9.0 kg	11.0 kg	16.6 kg	17.0 kg

V-i2120

R32 Only Vacuum Pump

Suitable for R32, 1234yf refrigerant



Large oil screen
Better visibility

High efficiency motor



High Reliability

High Efficiency Motor

- More efficient
- Higher ultimate vacuum

Large Oil Screen

- Better visibility

Model	V-i2120
Flow Rate	12 CFM 340 L/min
Partial Pressure	2x10 ⁻³ Pa
Total Pressure	15 micron
Power	1 HP
Inlet Port	1/4" & 3/8" SAE
Oil Capacity	500 ml
Dimensions	345x135x280 mm
Weight	11.5 kg

VPO-46

Vacuum Pump Oil



Model	VPO-46
Kinematic viscosity(40 °C)	41.4-50.6mm ² /s
Viscosity Index	110
Flash Point	240 °C
Pour Point	-10 °C
Capacity	230ml, 280ml, 330ml, 500ml
Type	Mineral Oil

Vacuum Pump Selection

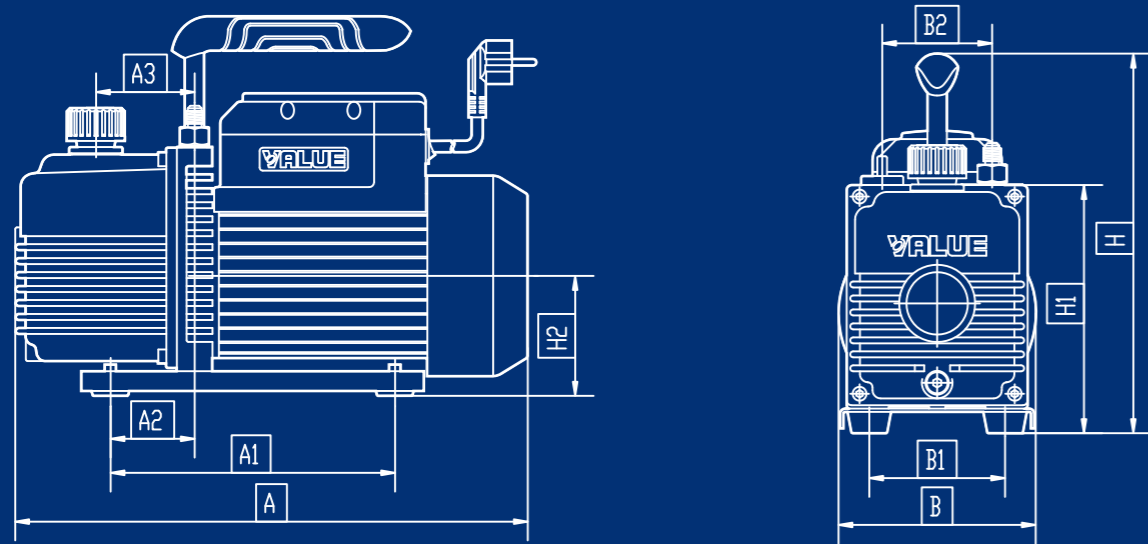
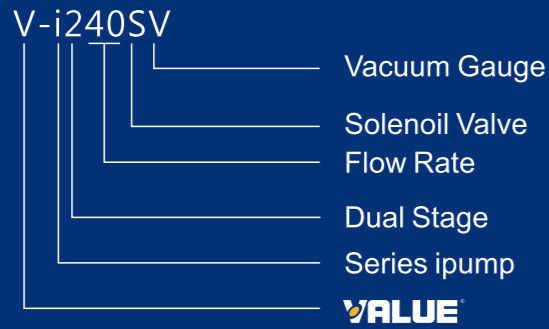

Unit:mm

Model	A	A1	A2	A3	B	B1	B2	H	H1	H2
VE115N	290	118	30	50	124	76	-	224	141	71
VE125N	290	118	30	50	124	76	-	224	141	71
VE135N	318	144	40	61	124	84	68	234	154	76
VE160N	338	144	40	61	138	84	74	244	166	78
VE180N	395	174	66	85	145	99	74	257	179	86
VE215N	308	118	30	50	124	76	-	224	141	71
VE225N	318	144	40	61	124	84	68	234	154	76
VE245N	338	144	40	61	138	84	74	244	166	78
VE260N	395	174	66	85	145	99	74	257	179	86
VE280N	395	174	66	85	145	99	74	257	179	86
VE2100N	395	174	66	85	145	99	74	257	179	86

Vacuum Pump Selection

Select by refrigerant

As for the vacuum supply of new refrigeration plants, vacuum pump with anti-backstreaming valve should be adopted. Otherwise there will be risk of backstreaming into the compressor, polluting and destroying the refrigerant ingredients, and influencing the refrigeration effect. i series pump could ensure high reliability.

Vacuum pump selection	i Series pump	N Series pump			R32 Series pump
Refrigerant	R410A	R407C	R22	R22	R32 1234yf
		R404A	R12	R12	
		R507A	R502	R502	
		R134a	R500	R500	

Select by pumping rate

The pumping rate of vacuum pump is generally indicated by L/min. The operation time is directly related to the pumping rate.

Vacuum pump selection	60~120L/min	180~240L/min	180~240L/min
Applicable machines	Household refrigerator	Central air conditioner	Central air conditioner
	Household air conditioner (below 5 Hp)	Large household air conditioner	Large refrigeration storage
		Bus air conditioner	
Car air conditioner	Large refrigeration storage		

Select by vacuum degree

Vacuum degree appears as Pa/micron. Higher vacuum degree is represented by smaller figures.

Vacuum pump selection	Single-stage vacuum pump	Double-stage vacuum pump
Vacuum degree	2 Pa/150micron	2x10 ³ Pa/15micron
Applicable machines	Household air conditioner	Central air conditioner
	Car air conditioner	Large and medium-sized refrigeration storage
	Refrigerator	

Power Series Vacuum Pump

Higher ultimate vacuum

We did individual analysis on special applications such as medical industry. Because large amount of corrosive gas and vapor needs to be pumped, we used stainless spring, fluorubber oil seal and etc. to upgrade our product, which ensures the pump to run reliably.



VRD-16/24/30 Options



Model		VRD-16	VRD-24	VRD-30
Displacement speed (m ³ /h)	50 Hz	16	24	30
	60 Hz	19.2	28.8	36
Ultimate partial pressure gas ballast close		4x10 ⁻² Pa	4x10 ⁻² Pa	4x10 ⁻² Pa
Ultimate total pressure gas ballast close		4x10 ⁻¹ Pa	4x10 ⁻¹ Pa	4x10 ⁻¹ Pa
Ultimate total pressure gas ballast open		8x10 ⁻¹ Pa	8x10 ⁻¹ Pa	8x10 ⁻¹ Pa
Power supply		single/3-ph	single/3-ph	single/3-ph
Power rating(kw)		0.75kW/0.55kW	1.1kW/0.75kW	1.1kW
Inlet and exhaust DN		KF25	KF25/40	KF25/40
Oil capacity(L)		0.9~1.5L	1.3~2.0L	1.3~2.0L
Motor speed (rpm)	50 Hz	1440	1440	1440
	60 Hz	1720	1720	1720
Ambient temperature		10~40°C	10~40°C	10~40°C
Noise level (dB)		≤ 58dB	≤ 58dB	≤ 58dB
Weight(Kg)		33kg	36kg	37kg

Power Series Vacuum Pump

Higher ultimate vacuum



Model		VP2120	VP2200
Displacement speed (m ³ /h)	50 Hz	20	36
	60 Hz	24	43
Ultimate partial pressure gas ballast close		4x10 ⁻² Pa	4x10 ⁻² Pa
Ultimate total pressure gas ballast close		4x10 ⁻¹ Pa	4x10 ⁻¹ Pa
Ultimate total pressure gas ballast open		8x10 ⁻¹ Pa	8x10 ⁻¹ Pa
Power supply		single/3-ph	single/3-ph
Power rating(kw)		0.75/0.55kW	1.1/0.75kW
Inlet and exhaust DN		7/16"-20UNF	7/16"-20UNF
Oil capacity(L)			1.3~2.0L
Motor speed (rpm)	50 Hz	1440	1440
	60 Hz	1720	1720
Ambient temperature		10~40°C	10~40°C
Noise level (dB)		≤ 58dB	≤ 58dB
Weight(kg)		37kg	41kg

Recovery Unit

Light · Fast

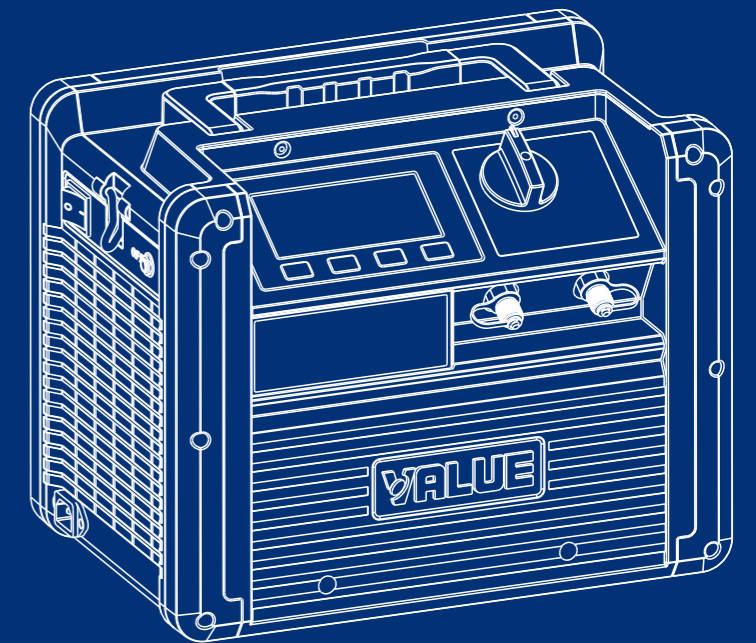

VRR12M Recovery Unit



Light • Compact

DC brushless Motor

- Faster recovery
- Lighter

High Pressure Protection

- Safe to use

Better Visibility

- Easy to read large LCD display
- Backlit display for clarity

Oil-free Compressor

- Suitable for all commonly used refrigerants

One Key Operation

- Easy to use

Self-purge Function

- Prevent mixing of various refrigerants

Model	VRR12M		
Refrigerant	Categories III : R12,R134a,R401C,R500,1234yf Categories IV : R22,R401A, R401B, R402B, R407C, R407D, R408A,R409A,R411A,R411B,R412A,R502,R509 Categories V : R402A,R404A,R407A,R407B,R410A,R507,R32		
Power Supply	220-240V~50/60Hz	115V~60Hz	
Motor	Brushless DC motor 3/4HP		
Motor Speed	3000 rpm		
Maximal Current Draw	2.6 A	5.5 A	
Compressor	Oil-less, Air-cooled, Piston style		
Automatic Safety Shut-Off	38.5bar/3850kPa(558psi)		
Recovery Rate (kg/min)		Categories III	Categories IV
	Vapor	0.20	0.25
	Liquid	1.76	1.98
	Push/Pull	4.60	5.60
Operating Temperature	0 °C-40 °C		
Dimensions	304×202×360 mm		
Weight	7.8 kg		

VRR24M-C Recovery Unit



Light • Fast

DC brushless Motor

- Faster recovery
- Lighter

Oil-free Compressor

- Suitable for all commonly used refrigerants

Better Visibility

- Easy to read large LCD display
- Backlit display for clarity

Self-purge Function

- Prevent mixing of various refrigerants

Micro Channel Condenser

- Fast recovery
- Better cooling performance compare to traditional condenser



Double condenser

Model	VRR24M-C		
Refrigerant	Categories III : R12, R134a, R401C, R500, 1234yf Categories IV : R22, R401A, R401B, R402B, R407C, R407D, R408A,R409A,R411A,R411B,R412A,R502,R509 Categories V : R402A,R404A,R407A,R407B,R410A,R507,R32		
Power Supply	220-240V~50/60Hz	115V~60Hz	
Motor	Brushless DC motor 1HP		
Motor Speed	3000 rpm		
Maximal Current Draw	6.5 A	12 A	
Compressor	Oil-less, Air-cooled, Piston style		
Automatic Safety Shut-Off	38.5bar/3850kPa(558psi)		
Recovery Rate (kg/min)		Categories III	Categories IV
	Vapor	0.43	0.54
	Liquid	3.60	4.00
	Push/Pull	7.50	8.50
Operating Temperature	0 °C-40 °C		
Dimensions	370×250×297 mm		
Weight	11 kg		

L Series Recovery Unit



L Series Recovery Unit



Light • Fast

One Key Operation

- Easy to use

High Pressure Protection

- Safe to use

Oil-free Compressor

- Suitable for all commonly used refrigerants

Self-purge Function

- Prevent mixing of various refrigerants

Model	VRR12L-R32		VRR12LOS-R32		
Refrigerant	Categories III : R12, R134a, R401C, R500, 1234fy Categories IV : R22, R401A, R401B, R402B, R407C, R407D, R408A, R409A, R411A, R411B, R412A, R502, R509 Categories V : R402A, R404A, R407A, R407B, R410A, R507, R32				
Power Supply	220V-240V~/50-60Hz	115V~/60Hz	220V-240V~/50-60Hz	115V~/60Hz	
Motor	3/4 HP	3/4 HP	3/4 HP	3/4 HP	
Motor Speed	1450rpm/1750rpm	1750rpm	1450rpm/1750rpm	1750rpm	
Maximal Current Draw	4 A	8 A	4 A	8 A	
Compressor	Oil-less, Air-cooled, Piston style				
Automatic Safety Shut-Off	38.5bar/3850kPa(558psi)				
Recovery Rate (kg/min)	Vapor	0.20	0.25	0.20	0.25
	Liquid	1.60	1.80	1.60	1.80
	Push/Pull	4.60	5.60	4.60	5.60
Operating Temperature	0 °C-40 °C				
Dimensions	450×250×355 mm				
Weight	13.0 kg		14.2 kg		

Light • Fast

One Key Operation

- Easy to use

Twin Cylinder

- Faster recovery

Oil-free Compressor

- Suitable for all commonly used refrigerants

Self-purge Function

- Prevent mixing of various refrigerants

High Pressure Protection

- Safe to use

Model	VRR24L-R32		VRR24LOS-R32		
Refrigerant	Categories III : R12, R134a, R401C, R500, 1234fy Categories IV : R22, R401A, R401B, R402B, R407C, R407D, R408A, R409A, R411A, R411B, R412A, R502, R509 Categories V : R402A, R404A, R407A, R407B, R410A, R507, R32				
Power Supply	220V-240V~/50-60Hz	115V~/60Hz	220V-240V~/50-60Hz	115V~/60Hz	
Motor	1 HP	1 HP	1 HP	1 HP	
Motor Speed	1450 rpm/1750 rpm	1750 rpm	1450 rpm/1750 rpm	1750 rpm	
Maximal Current Draw	5 A	10 A	5 A	10 A	
Compressor	Oil-less, Air-cooled, Piston style				
Automatic Safety Shut-Off	38.5bar/3850kPa(558psi)				
Recovery Rate (kg/min)	Vapor	0.40	0.50	0.40	0.50
	Liquid	3.00	3.50	3.00	3.50
	Push/Pull	7.50	8.50	7.50	8.50
Operating Temperature	0°C-40°C				
Dimensions	450×250×355 mm				
Weight	13.5 kg		14.7 kg		

L Series Recovery Unit



Light • Fast

One Key Operation

- Easy to use

Self-purge Function

- Prevent mixing of various refrigerants

Oil-free Compressor

- Suitable for all commonly used refrigerants

High Pressure Protection

- Safe to use

Model	VRR12L	VRR12L-OS					
Refrigerant	Categories III : R12, R134a, R401C, R500 Categories IV : R22, R401A, R401B, R402B, R407C, R407D, R408A, R409A, R411A, R411B, R412A, R502, R509 Categories V : R402A, R404A, R407A, R407B, R410A, R507						
Power Supply	220-240V~/50-60Hz	115V~/60Hz	220V-240V~/50-60Hz	115V~/60Hz			
Motor	3/4 HP	3/4 HP	3/4 HP	3/4 HP			
Motor Speed	1450 rpm/1750 rpm	1750 rpm	1450 rpm/1750 rpm	1750 rpm			
Maximal Current Draw	4 A	8 A	4 A	8 A			
Compressor	Oil-less, Air-cooled, Piston style						
Automatic Safety Shut-Off	38.5bar/3850kPa(558psi)						
Recovery Rate (kg/min)		Categories III	Categories IV	Categories V	Categories III	Categories IV	Categories V
	Vapor	0.20	0.25	0.25	0.20	0.25	0.25
	Liquid	1.60	1.80	2.20	1.60	1.80	2.20
	Push/Pull	4.60	5.60	6.30	4.60	5.60	6.30
Operating Temperature	0°C-40°C						
Dimensions	400×250×355 mm						
Weight	13.0 kg		14.2 kg				

L Series Recovery Unit



Light • Fast

One Key Operation

- Easy to use

Twin Cylinder

- Faster recovery

Oil-free Compressor

- Suitable for all commonly used refrigerants

Self-purge Function

- Prevent mixing of various refrigerants

High Pressure Protection

- Safe to use

Model	VRR24L	VRR24L-OS					
Refrigerant	Categories III : R12, R134a, R401C, R500 Categories IV : R22, R401A, R401B, R402B, R407C, R407D, R408A, R409A, R411A, R411B, R412A, R502, R509 Categories V : R402A, R404A, R407A, R407B, R410A, R507						
Power Supply	220-240V~/50-60Hz	115V~/60Hz	220V-240V~/50-60Hz	115V~/60Hz			
Motor	1 HP	1 HP	1 HP	1 HP			
Motor Speed	1450 rpm/1750 rpm	1750 rpm	1450 rpm/1750 rpm	1750 rpm			
Maximal Current Draw	5 A	10 A	5 A	10 A			
Compressor	Oil-less, Air-cooled, Piston style						
Automatic Safety Shut-Off	38.5bar/3850kPa(558psi)						
Recovery Rate (kg/min)		Categories III	Categories IV	Categories V	Categories III	Categories IV	Categories V
	Vapor	0.40	0.50	0.50	0.40	0.50	0.50
	Liquid	3.00	3.50	3.50	3.00	3.50	3.50
	Push/Pull	7.50	8.50	9.50	7.50	8.50	9.50
Operating Temperature	0°C-40°C						
Dimensions	450×250×355 mm						
Weight	13.5 kg		14.7 kg				

Refrigerant Tools

Accurate

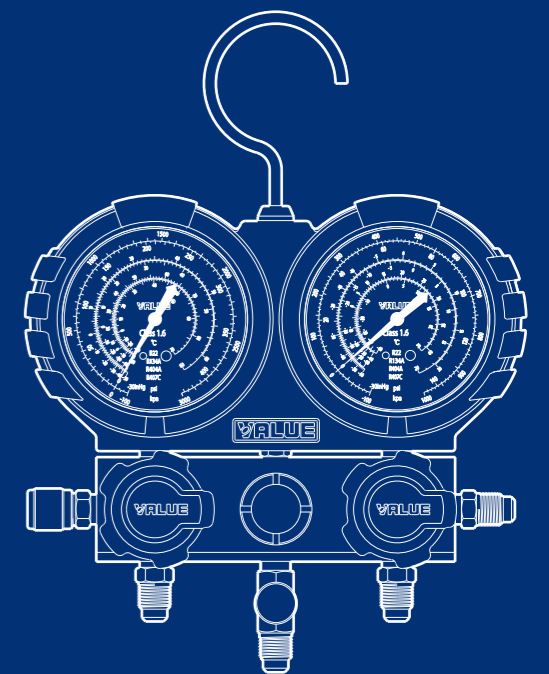

Manifold Gauge

Suitable for R32, R407, R410A, R134a, 1234yf refrigerant

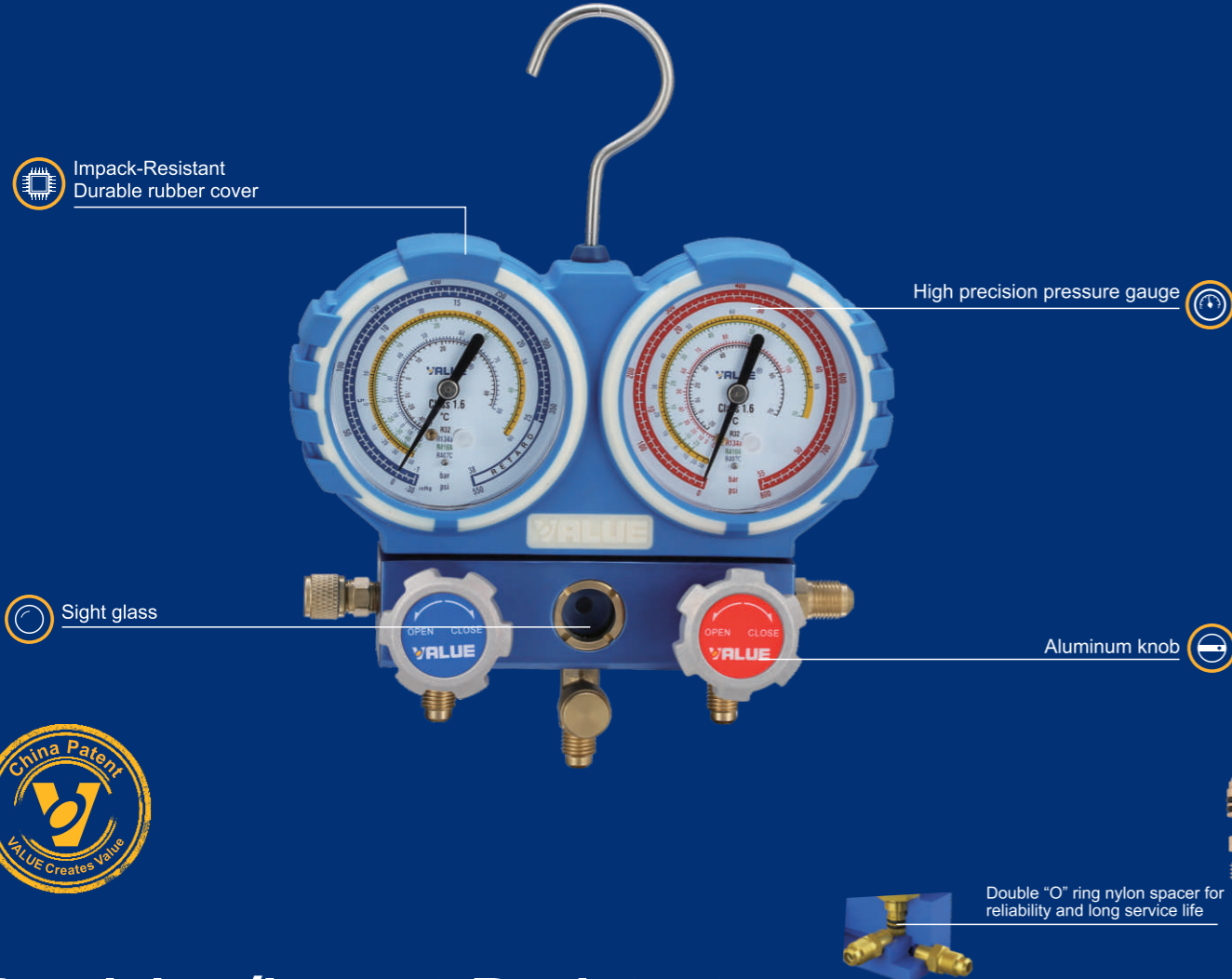

Precision/Impact-Resistant

Impact-resistant

- Impact-Resistant design
- Durable rubber cover

Accurate

- Precision pressure gauge

Aluminum knob

- Anti corrosion

Sight Glass

- Easily view refrigerant movement and condition during charging and recovery

Model	VMG-2-R32	VMG-2-R32-B-03	VMG-2-1234yf
Refrigerant	R32	R32, R407, R410A, R134a	1234yf
Gauge Diameter	Φ80 mm	Φ68 mm	Φ80 mm
Pressure Scale	-30inHg~800 psi; -30inHg~500 psi		-30inHg~400 psi; -30inHg~130 psi
Hose	Red&Blue: 1/4"-5/16", 2x1pc Yellow: 1/4"-1/4", 1pc	/	Red&Blue: M12X1.5 - M12X1.5, 2X1pc Yellow: M12X1.5 - 1/2" Acme, 1pc
Length	3x120 cm	/	150 cm
Package	Blow Case	Blister packing	Blow Case

Manifold Gauge

VMG-2-R600-B

Model	VMG-2-R600-B	VMG-2-R600-B-03
Refrigerant	R600, R600a, R290	R600, R600a, R290
Gauge Diameter	Φ68 mm	Φ68 mm
Pressure Scale	-30inHg ~ 435 psi; -30inHg ~ 130 psi	-30inHg ~ 435 psi; -30inHg ~ 130 psi
Hose	Red&Blue&Yellow: 1/4"-1/4", 3x1 pc	/
Length	120 cm	/
Package	Blow Case	Blister packing

VMG-2-R22

Model	VMG-2-R22	VMG-2-R22-02	VMG-2-R22-03
Refrigerant	R404A, R407C, R134a, R22	R404A, R407C, R134a, R22	R404A, R407C, R134a, R22
Gauge Diameter	Φ80 mm	Φ80 mm	Φ80 mm
Pressure Scale	-30inHg ~ 400 psi; -30inHg ~ 140 psi	-30inHg ~ 400 psi; -30inHg ~ 140 psi	-30inHg ~ 400 psi; -30inHg ~ 140 psi
Hose	Red&Blue&Yellow: 1/4"-1/4", 3x1 pc	Red&Blue&Yellow: 1/4"-1/4", 3x1 pc	/
Length	120 cm	120 cm	/
Package	Blow Case	Blister packing	Blister packing

Model	VMG-2-R22-B	VMG-2-R22-B-02	VMG-2-R22-B-03
Refrigerant	R404A, R407C, R134a, R22	R404A, R407C, R134a, R22	R404A, R407C, R134a, R22
Gauge Diameter	Φ68 mm	Φ68 mm	Φ68 mm
Pressure Scale	-30inHg ~ 400 psi; -30inHg ~ 140 psi	-30inHg ~ 400 psi; -30inHg ~ 140 psi	-30inHg ~ 400 psi; -30inHg ~ 140 psi
Hose	Red&Blue&Yellow: 1/4"-1/4", 3x1 pc	Red&Blue&Yellow: 1/4"-1/4", 3x1 pc	/
Length	120 cm	120 cm	/
Package	Blow Case	Blister packing	Blister packing

VMG-2-R410A

Model	VMG-2-R410A	VMG-2-R410A-02	VMG-2-R410A-03	VMG-2-R410A-04	VMG-2-R410A-05
Refrigerant	R410A	R410A, R407C, R134a, R22			R410A, R407C, R404A, R134a
Gauge Diameter	Φ80 mm				
Pressure Scale	0~800 psi; -30inHg ~ 500 psi				
Hose	Red&Blue: 1/4"-5/16", 2x1 pc Yellow: 1/4"-1/4", 1 pc	Red&Blue: 1/4"-5/16", 2x1 pc Yellow: 1/4"-1/4", 1 pc With 2 pcs adapters	Red&Blue: 1/4"-5/16", 2x1 pc Yellow: 1/4"-1/4", 1 pc	/	Red&Blue: 1/4"-5/16", 2x1 pc Yellow: 1/4"-1/4", 1 pc
Length	150 cm				
Package	Blow case	Blow case	Blister packing	Blister packing	Blister packing

Model	VMG-2-R410A-B	VMG-2-R410A-B-02	VMG-2-R410A-B-03
Refrigerant	R410A, R407C, R134a, R22	R410A, R407C, R134a, R22	R410A, R407C, R134a, R22
Gauge Diameter	Φ68 mm	Φ68 mm	Φ68 mm
Pressure Scale	0 ~ 800 psi; -30 ~ 500 psi	0 ~ 800 psi; -30inHg ~ 500 psi	0 ~ 800 psi; -30inHg ~ 500 psi
Hose	Red&Blue: 1/4"-5/16", 2x1 pc Yellow: 1/4"-1/4", 1 pc	Red&Blue: 1/4"-5/16", 2x1 pc Yellow: 1/4"-1/4", 1 pc	/
Standard Length	120 cm		
Package	Blow case	Blister packing	Blister packing

NOTICE: All information listed above is standard size, if you require other size, please appoint in the order.

VMG-4-R410A

Manifold Gauge

Suitable for R410A refrigerant

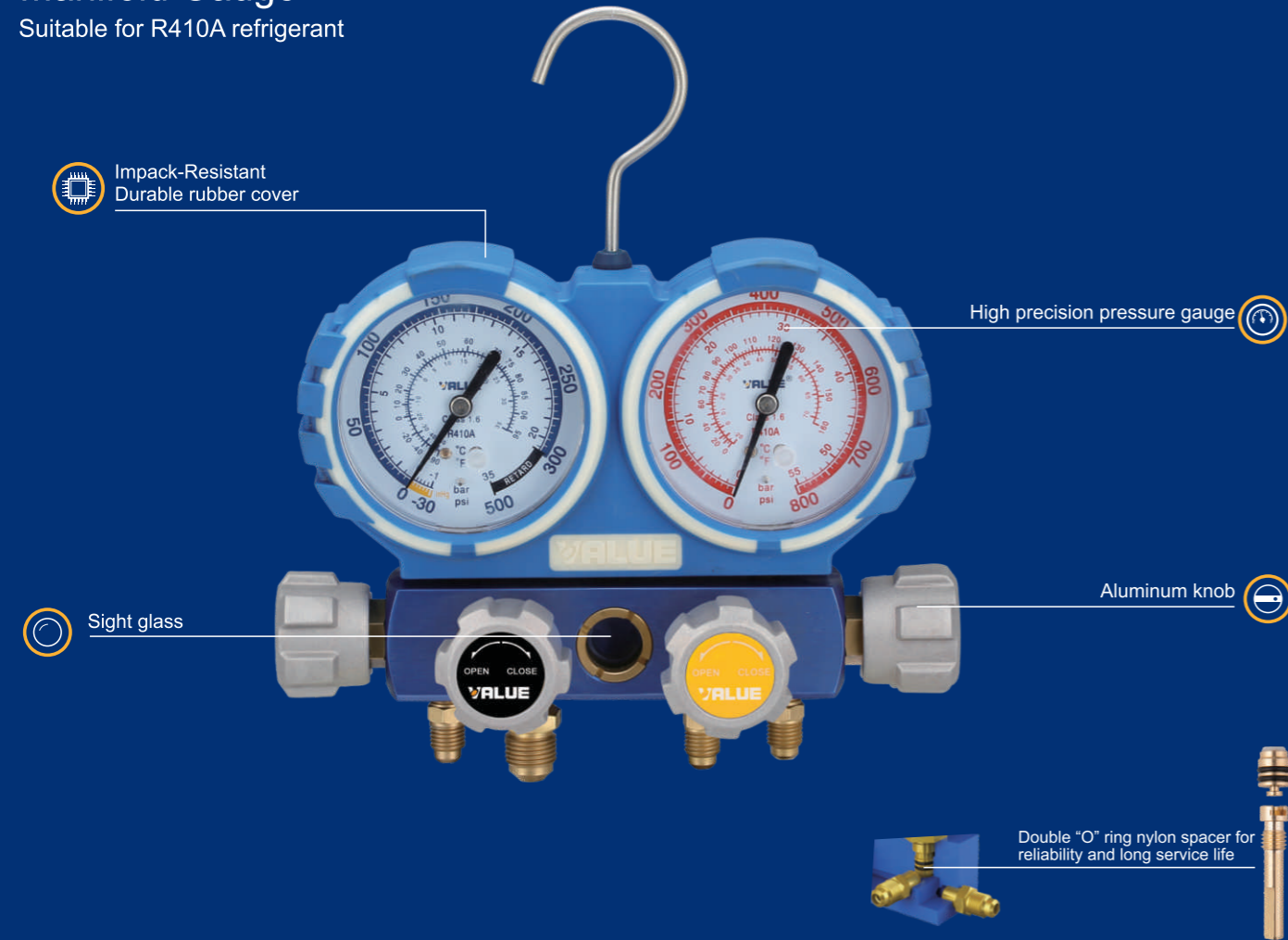

Manifold Gauge

Suitable for R134a refrigerant

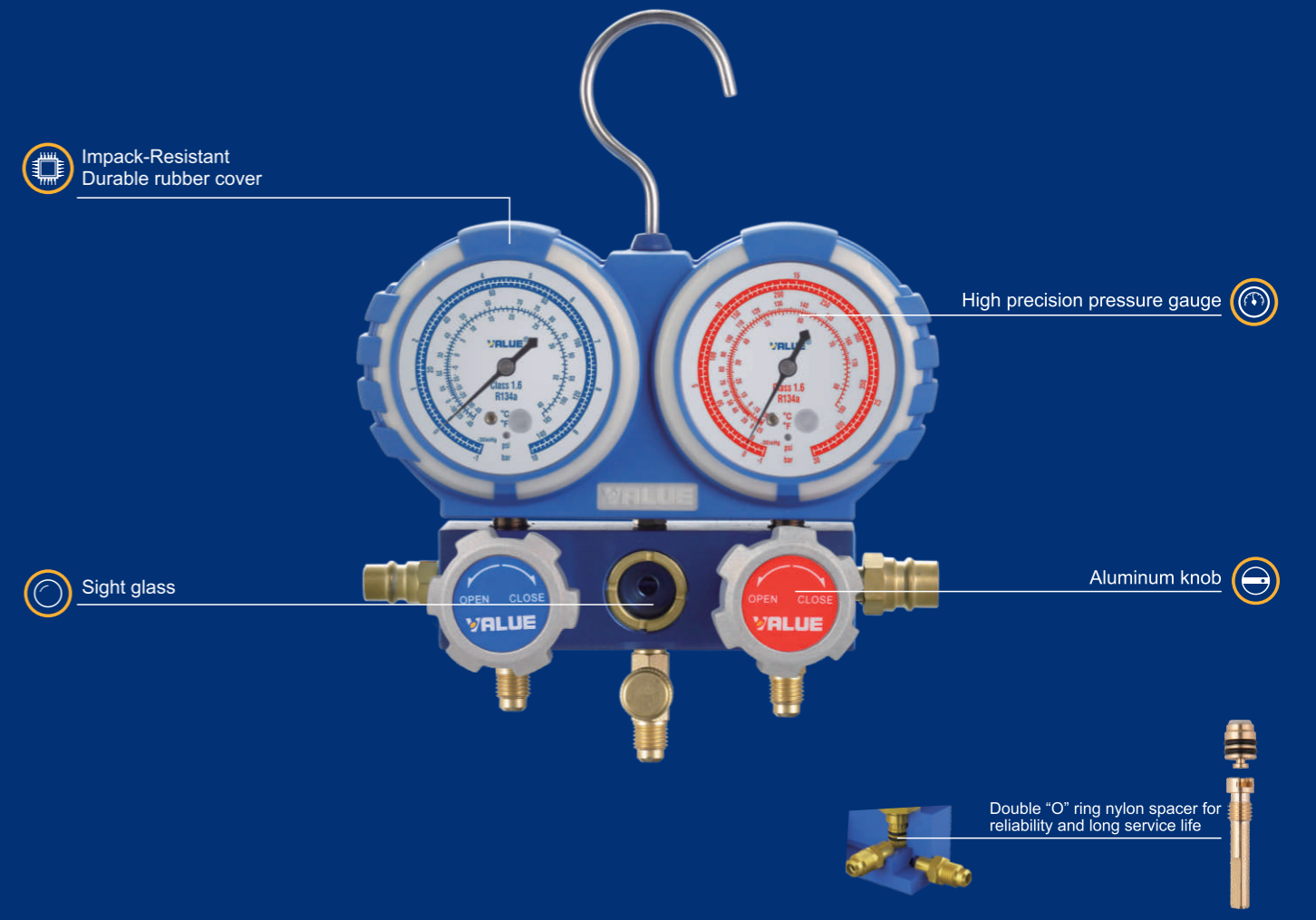

Precision/Impact-Resistant

Impact-resistant

- Impact-Resistant design
- Durable rubber cover

Accurate

- Precision pressure gauge

Aluminum knob

- Anti corrosion

Sight Glass

- Easily view refrigerant movement and condition during charging and recovery

Model	VMG-4-R410A
Refrigerant	R410A
Gauge Diameter	Φ80 mm
Pressure Scale	-30inHg ~ 800 psi; -30inHg ~ 500 psi
Hose	Red&Blue: 1/4"-5/16", 2x1 pc Yellow: 1/4"-1/4", 1 pc Black: 3/8"-3/8", 1 pc
Length	150 cm
Package	Blow Case

Precision/Impact-Resistant

Impact-resistant

- Impact-Resistant design
- Durable rubber cover

Accurate

- Precision pressure gauge

Aluminum knob

- Anti corrosion

Sight Glass

- Easily view refrigerant movement and condition during charging and recovery

Model	VMG-2-R134a	VMG-2-R134a-B	VMG-2-R134a-02	VMG-2-R134a-B-02
Refrigerant	R134a			
Gauge Diameter	Φ80 mm	Φ68 mm	Φ80 mm	Φ68 mm
Pressure Scale	-30inHg~400 psi; -30inHg~140 psi		-30inHg ~ 400 psi; -30inHg ~ 140 psi	
Hose	Red & Blue & Yellow: 1/4"-1/4", 3x1pc		Red & Blue: 1/2"Acme, M14x1.5, 2x1pc Yellow: 1/2"Acme, 1/2"Acme, 1pc	
Length	120 cm		120 cm	
Package	Blow Case		Blow Case	
Quick Couplers	VHF-SA 1set		VHF-SB 1set	

Single Gauge



Impact-Resistant
Durable rubber cover

High precision pressure gauge

Sight glass

Aluminum knob

Precision/Impact-Resistant

Impact-resistant

- Impact-Resistant design
- Durable rubber cover

Accurate

- Precision pressure gauge

Aluminum knob

- Anti corrosion

Sight Glass

- Easily view refrigerant movement and condition during charging and recovery

Model	VMG-1-U-H	VMG-1-U-L	VMG-1-S-H	VMG-1-S-L
Gauge Diameter	Φ68 mm			
Refrigerant (Optional)	ABH/ABL	R134a		
	BBH/ABL	R22/R134a/R404A/R407C		
	CBH/CBL	R22/R134a/R410A/R407C		
	DBH/DBL	R410A		
	EBH/EBL	R404A/R134a/R410A/R407C		
	FBH/FBL	R600/R600a/R290		
Pressure Scale	-30 inHg ~ 800 psi	-30 inHg ~ 500 psi	-30 inHg ~ 800 psi	-30 inHg ~ 500 psi
Sight glass	Without		With	
Package	Blister packing			





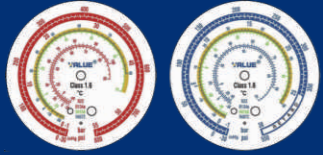
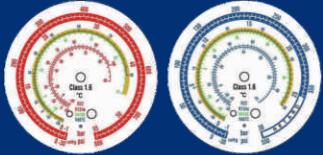
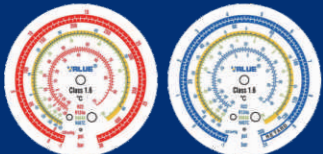
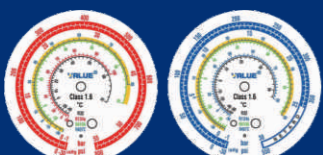
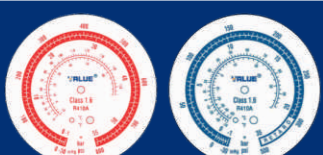
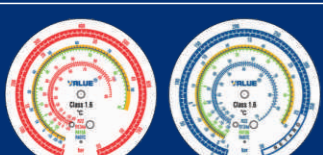
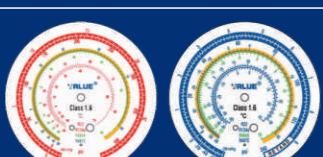
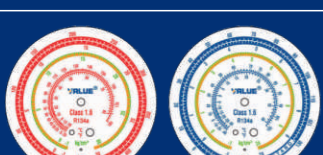
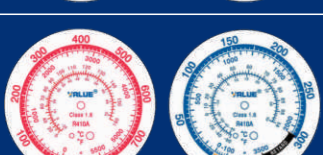

Pressure Gauge

High / Low Pressure Gauge	Gauge Diameter	Unit	Refrigerant	MRP NO.	Thread
	Φ68 mm	°C/°F/ Psi/Bar	R134a	342260108 342260109	NPT1/8"
	Φ68 mm	°C/Psi/Bar	R22 R134a R404A R407C	342260110 342260111	NPT1/8"
	Φ68 mm	°C/Psi/Bar	R22 R134a R410A R407C	342260112 342260113	NPT1/8"
	Φ68 mm	°C/°F/ Psi/Bar	R410A	342260114 342260115	NPT1/8"
	Φ68 mm	°C/Psi/Bar	R404A R134a R410A R407C	342260118 342260119	NPT1/8"
	Φ68 mm	Psi/Bar	R600 R600a R290	342266427 342266428	NPT1/8"
	Φ68 mm	Psi/Bar	R22 R410A R32	342260122 342260123	NPT1/8"
	Φ68 mm	Psi/Bar	R32 R134a R410A R407C	342260124 342260125	NPT1/8"

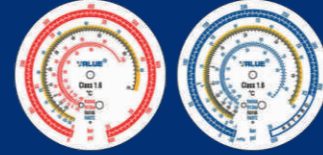
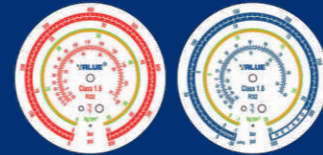
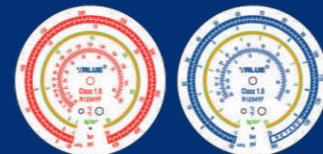
Pressure Gauge

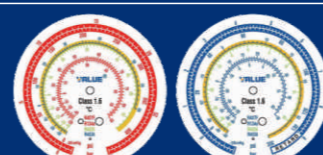
High / Low Pressure Gauge	Gauge Diameter	Unit	Refrigerant	MRP NO.	Thread
	Φ68mm	°C/Psi/Bar	R22 R134a R410A R407C	342260112 342260113	NPT1/8"
	Φ68mm	°C/Pis/Bar	R22 R134a R410A R407C	342266501 342266502	NPT1/8"
	Φ68mm	°C/Psi/Bar	R22 R134a R404A R407C	342266110 342266110	NPT1/8"
	Φ68mm	°C/Psi/Bar	R32 R134a R410A R407C	342266124 342266125	NPT1/8"
	Φ80 mm	°C°/F/Pis/Bar	R410A	342260101 342260102	NPT1/8"
	Φ80 mm	°C/Psi/Bar	R22 R134a R410A R407C	342260104 342260105	NPT1/8"
	Φ80 mm	°C/Psi/kg/cm ²	R22 R134a R404A R407C	342260401 342260402	NPT1/8"
	Φ80 mm	°C°/F/Psi/ Bar/kg/cm ²	R134a	342260405 342260406	NPT1/8"
	Φ80 mm	°C°/F/Psi/kPa	R410A	342260409 342260410	NPT1/8"

Pressure Gauge

High / Low Pressure Gauge	Gauge Diameter	Unit	Refrigerant	MRP NO.	Thread
	Φ80 mm	°C/Bar/Psi	R404A R134a R410A R407C	342260411 342260412	NPT1/8"
	Φ80 mm	°C°/F/Psi/ Bar/kg/cm ²	R32	342260413 342260414	NPT1/8"
	Φ80 mm	°C°/F/Psi/ Bar/kg/cm ²	1234yf	342260415 342260416	NPT1/8"
	Φ80 mm	°C/Psi/Bar	R32 R134a R410A R407C	342260421 342260422	NPT1/8"
	Φ80mm	°C/Psi	R134a	342260407 342260408	NPT1/8"
	Φ80mm	°C/Psi/Bar	R407F R134a R442A R453A	342260419 342260420	NPT1/8"
	Φ80mm	°C/Bar/Psi	R134a R404A R448A R452A	342260437 342260438	NPT1/8"
	Φ80mm	°C/Bar/Pis	R449A R404A R448A R452A	342260441 342260442	NPT1/8"
	Φ80mm	°C/Bar/Pis	R134a R404A R449A R452A	342260445 342260446	NPT1/8"

VDG-1

Digital Manifold Gauge

Suitable for R32, R410A, R22, 1234yf, R134a refrigerant

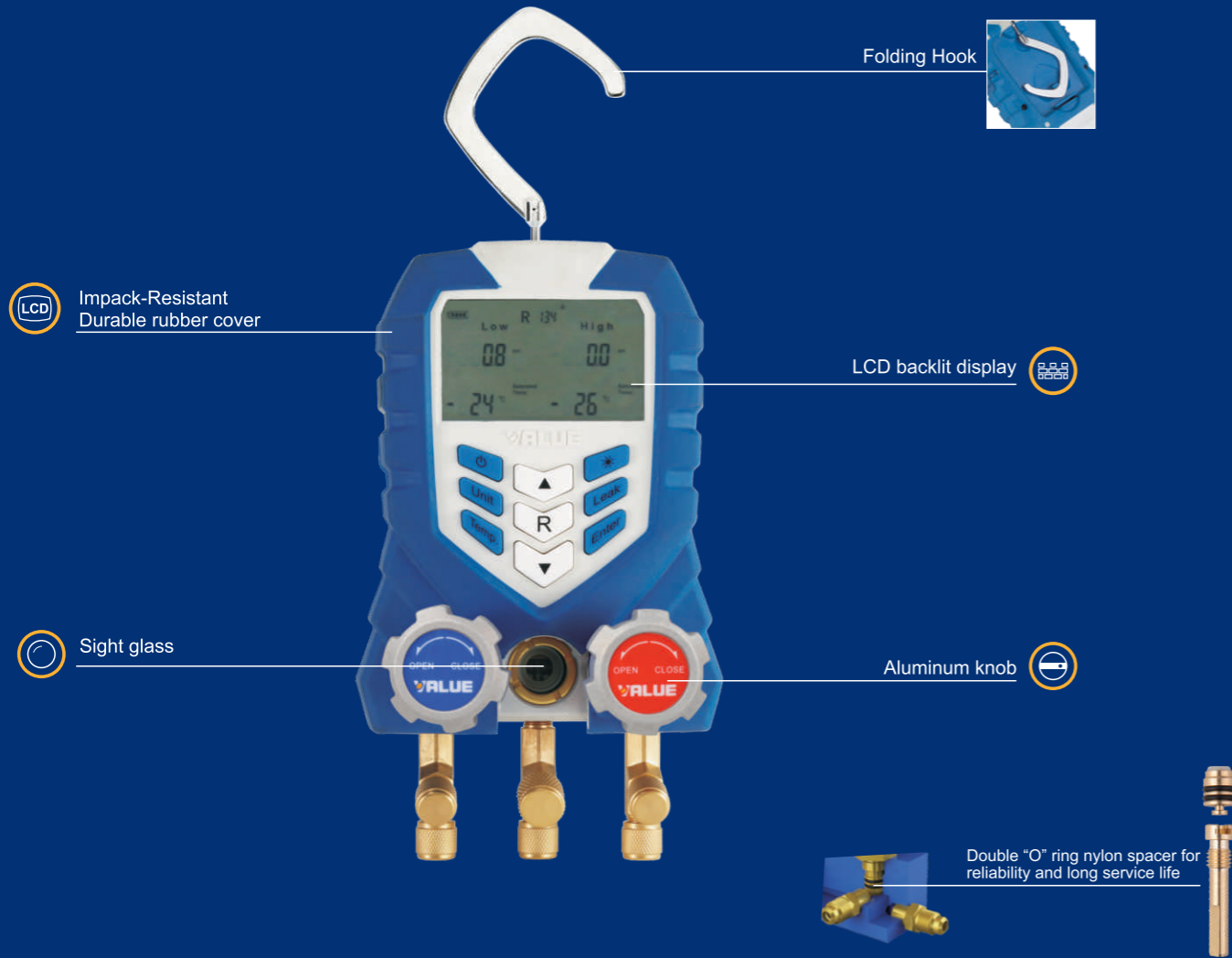

VDG-S1

Digital Single Gauge

Suitable for R22, R134a, 1234yf, R290, R404A, R407C, R410A, R32, R507 refrigerant

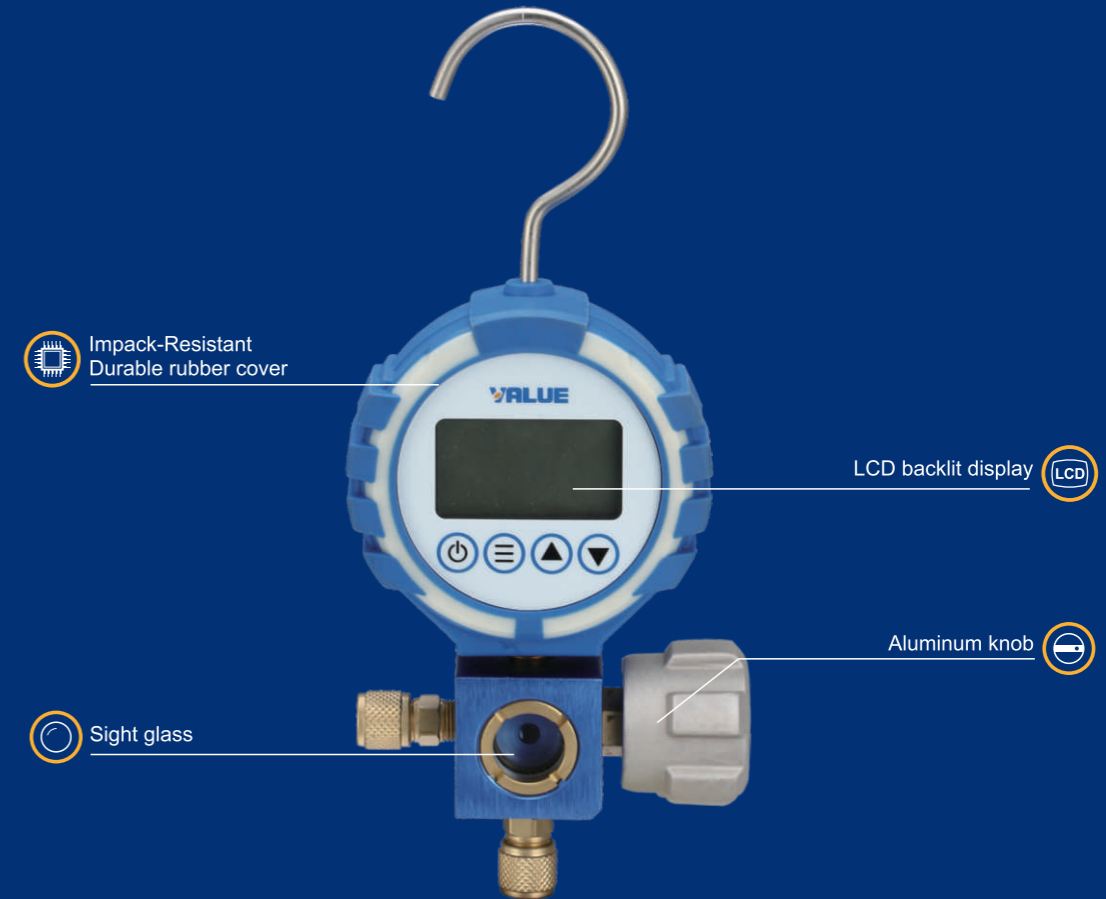

Precision/Impact-Resistant

Impact-resistant

- Impact-Resistant design
- Durable rubber cover

Accurate

- Precision pressure gauge

LCD Backlit Display

- Clearly display, easy to read

Sight Glass

- Easily view refrigerant movement and condition during charging and recovery

Wide Range of Application

- Suit for more than 40 refrigerants

Aluminum knob

- Anti corrosion

Model	VDG-1
Operating temperature	10-90% RH
Measuring range pressure	-14.5-725 psi
Net weight	1.2 kg

Precision/Impact-Resistant

Impact-resistant

- Impact-Resistant design
- Durable rubber cover

Accurate

- Precision pressure gauge

LCD Backlit Display

- Clearly display, easy to read

Sight Glass

- Easily view refrigerant movement and condition during charging and recovery

Wide Range of Application

- Suit for 9 refrigerants

Aluminum knob

- Anti corrosion

Model	VDG-S1
Refrigerant	R22, R134a, 1234yf, R290, R404A, R407C, R410A, R32, R507
Pressure display	psi bar Kpa Mpa kgf/cm ²
Pressure resolution	1 psi; 0.1 bar; 10 kPa; 0.01 Mpa; 0.1 kgf/cm ²
Connection	2x1/4" SAE
Power	9 V battery

VDG-2-S1

Digital Manifold Gauge

Suitable for R22, R134a, 1234yf, R290, R404A, R407C, R410A, R32, R507 refrigerant

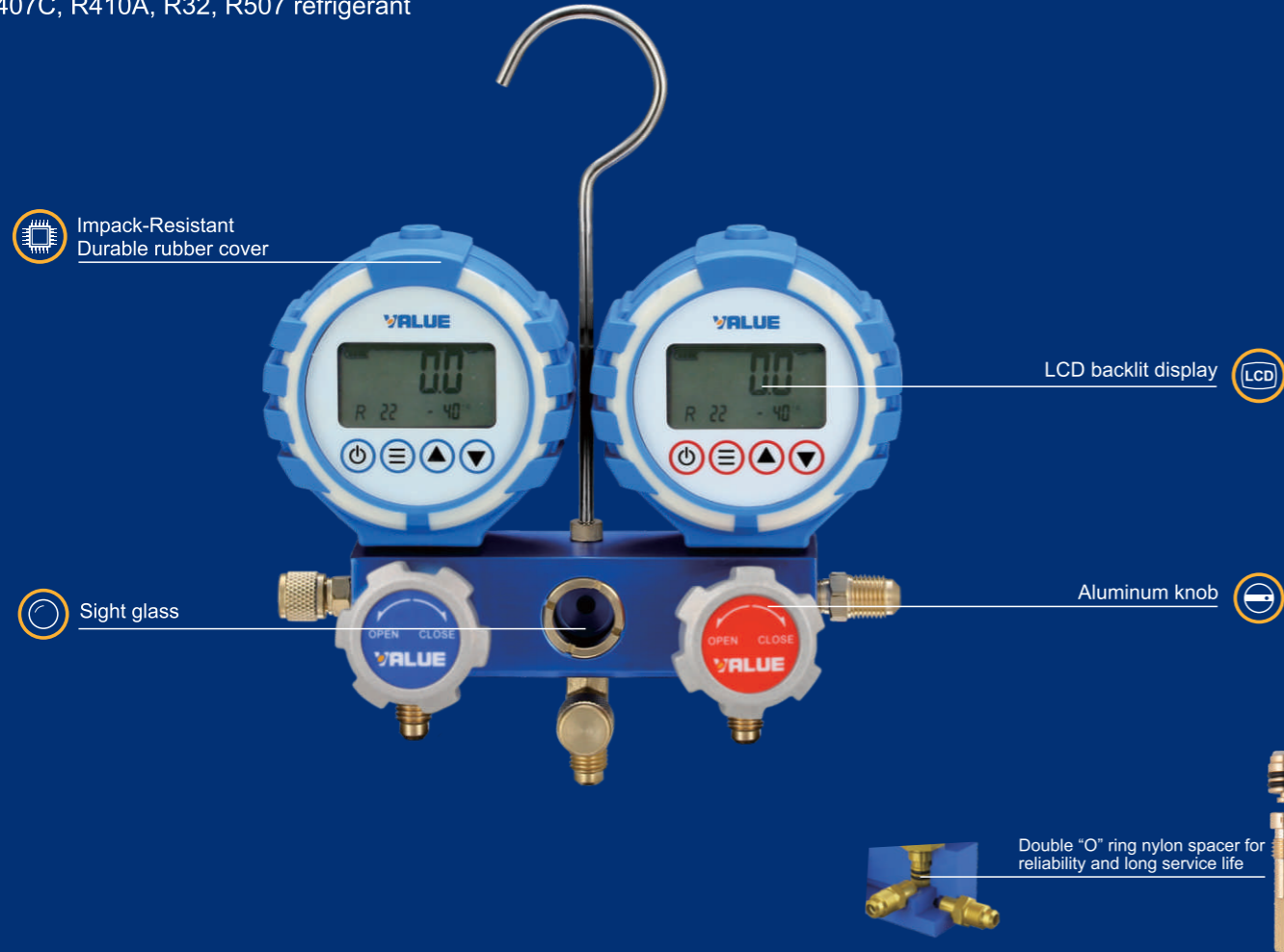

Precision/Impact-Resistant

Impack-resistant

- Impack-Resistant design
- Durable rubber cover

Accurate

- Precision pressure gauge

LCD Backlit Display

- Clearly display, easy to read

Sight Glass

- Easily view refrigerant movement and condition during charging and recovery

Wide Range of Application

- Suit for 9 refrigerants

Aluminum knob

- Anti corrosion

Model	VDG-2-S1
Refrigerant	R22, R134a, 1234yf, R290, R404A, R407C, R410A, R32, R507
Pressure display	psi bar Kpa Mpa kgf/cm ²
Pressure resolution	1 psi; 0.1 bar; 10 kPa; 0.01 Mpa; 0.1 kgf/cm ²
Hose	Red & Blue: 1/4"-5/16", 2x150 cm Yellow: 1/4"-1/4", 150 cm
Power	9V*2 battery

VDG-4-S1

Digital Manifold Gauge

Suitable for R22, R134a, 1234yf, R290, R404A, R407C, R410A, R32, R507 refrigerant

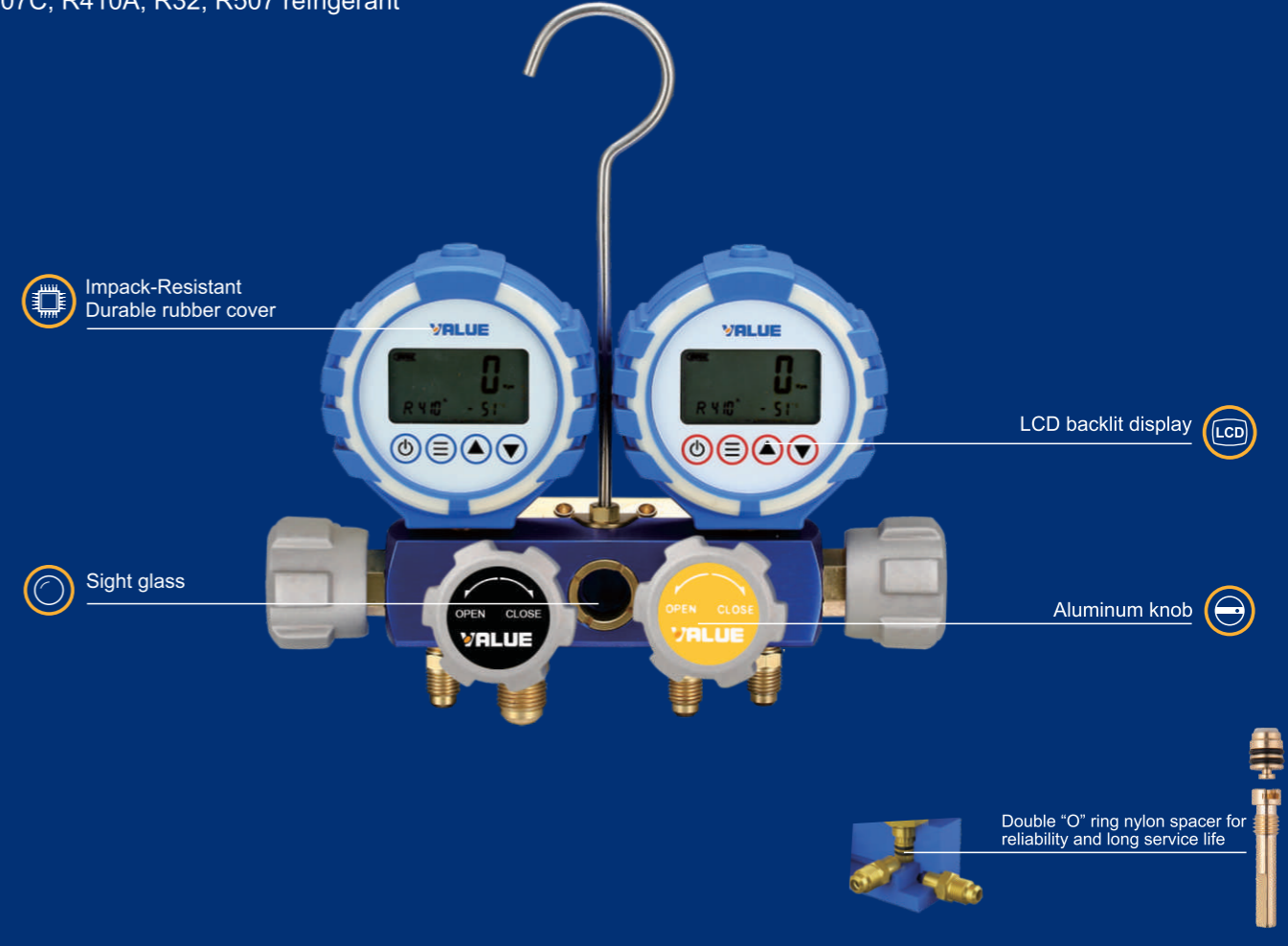

Precision/Impact-Resistant

Impack-resistant

- Impack-Resistant design
- Durable rubber cover

Accurate

- Precision pressure gauge

LCD Backlit Display

- Clearly display, easy to read

Sight Glass

- Easily view refrigerant movement and condition during charging and recovery

Wide Range of Application

- Suit for 9 refrigerants

Aluminum knob

- Anti corrosion

Model	VDG-4-S1
Refrigerant	R22, R134a, 1234yf, R290, R404A, R407C, R410A, R32, R507
Pressure display	psi bar Kpa Mpa kgf/cm ²
Pressure resolution	1 psi; 0.1 bar; 10 kPa; 0.01 Mpa; 0.1 kgf/cm ²
Hose	Red & Blue: 1/4"-5/16", 2x150 cm Yellow: 1/4"-1/4", 150 cm Black: 3/8"-3/8", 150 cm
Power	9V*2 battery

Quick Coupler

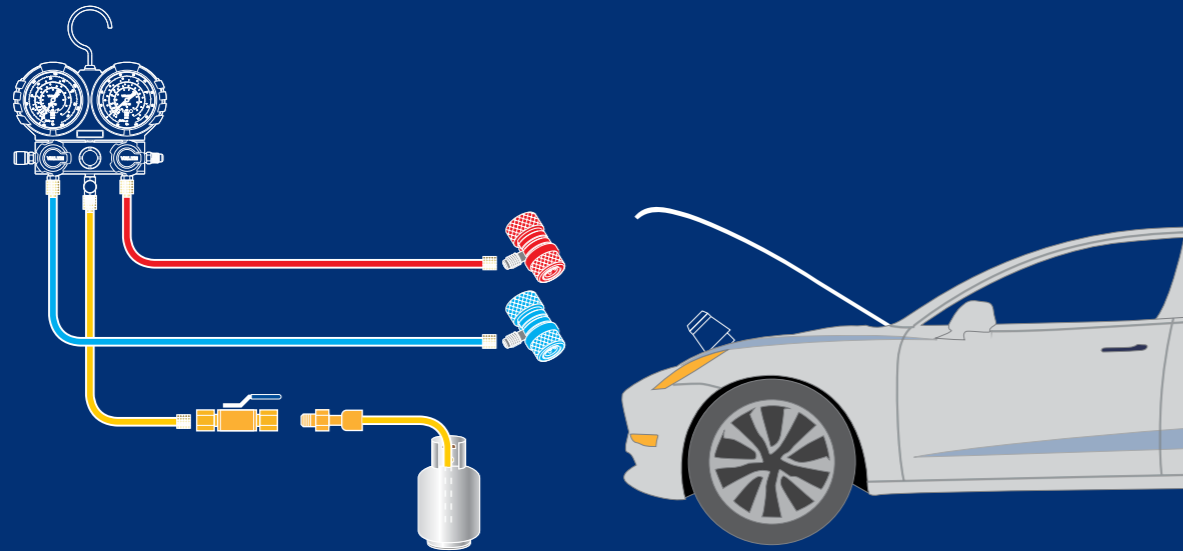

Quick-connect

Easy to Use

- Automatically lock, one-step connection

Durable

- High strength, high pressure resistance
- Long service life

High Oil-resistance, Anti-seeping

- 3-layer reinforce refrigerant tube, Effective avoid seeping
- Longitudinal die-casting seal, prevent leakage of connector

VHF quick couples series

Model	VHF-SA	VHF-SB	VHF-SC	VHF-SY
Description	1/4" SAE	M14 × 1.5	3/8" SAE	M12 × 1.5

Refrigerant Hose

3-layer anti-sweeping refrigerant hose

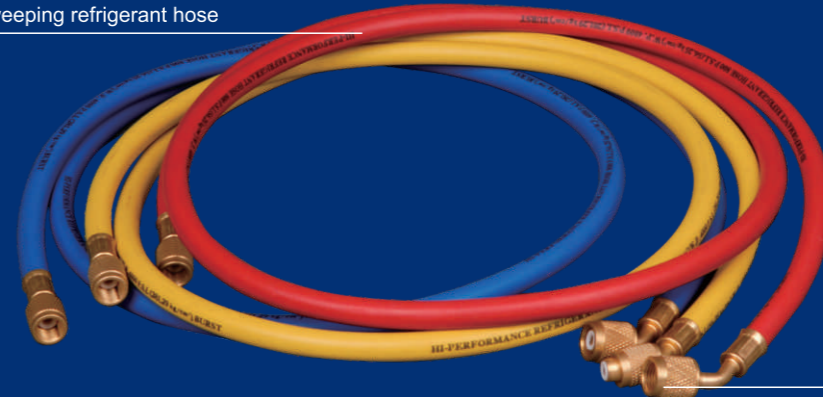

Pure copper connector



Check Valve

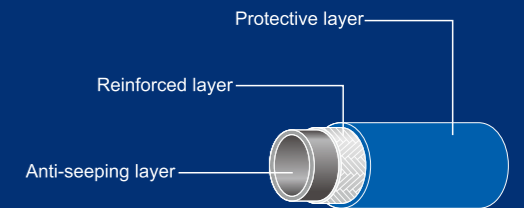

High strength

Wide Range of Application

- It's suit for R410A, R134a, R22, etc

Safe and Reliable

- Rubber tube reinforced thickness 12mm, Ensure safe and reliable using

High Oil-resistance, Anti-seep

- 3 layer reinforce refrigerant tube, Effective avoid seeping
- Pure copper connector, Longitudinal die-casting

Check Valve

- Effectively complete the pipeline switching

Model	R410A	R134a
Working pressure	0 ~ 800 psi	0~500 psi
VRP-U-R	1/4"-5/16"	1/4"-1/4"
VRP-U-Y	1/4"-1/4"	1/4"-1/4"
VRP-U-B	1/4"-5/16"	1/4"-1/4"
Length	90 cm 120 cm 150 cm	

Model	R410A	R134a, R22, R12	R134a, R22, R12
Working pressure	0~800 psi	0~500 psi	0~500 psi
VRP-C-R	1/4"-5/16"	1/4"-1/4"	1/2" M14x1.5
VRP-C-Y	1/4"-1/4"	1/4"-1/4"	1/2" -1/2"
VRP-C-B	1/4"-5/16"	1/4"-1/4"	1/2" M14x1.5
Length	90 cm 120 cm 150 cm		

Big Boy High-Flow Evacuation Hoses



For best evacuation performance, Use VALUE VCR1 Valve Core Removal Tool

VCR1 Valve Core Removal Tool

2 sizes in 1 tool



Evacuation Hose

Fast & Efficient

- 1/2" large diameter for fast evacuation
- 4-layer construction for low permeation
- 3200 psi burst pressure, 640 psi working pressure
- Vacuum rated to 20 microns

Model	VHB-1	VHB-2
Length	180 cm	180 cm
Diameter	1/2"	1/2"
Fitting	3/8" - 1/4" SAE	1/2" - 1/4" SAE

Fast Recovery and Evacuation

For Use With Both 1/4" and 5/16" Flare Fittings

Rated For R410A Systems

Vacuum Rated to 20 Microns

Metal Handle for Durability

Valve Opener

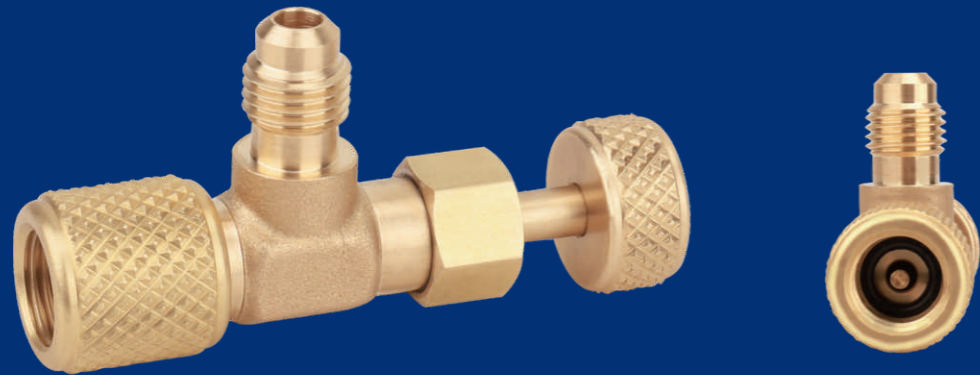

Safe, low leakage

Model	VVO-1	VVO-2	VVO-3
Size	1/4"-1/4"SAE	1/4"-5/16"SAE	5/16"-5/16"SAE

Check Valve



Item	Description	Item	Description
CV01	Male: 1/4"SAE Female: 5/16" SAE	Cv07	Male: 1/4"SAE Female: 1/4" SAE
CV02	Male: 1/4"SAE Female: 5/16" SAE 45°	CV08	Male: 5/16"SAE Female: 5/16"SAE 45°
CV03	Male: 1/4"SAE Female: 5/16" SAE 60°	CV09	Male: 5/16"SAE Female: 5/16"SAE 60°
CV04	Male: 5/16"SAE Female: 5/16" SAE	CV10	Male: 5/16"SAE Female: 1/4" SAE
CV05	Male: 1/4"SAE Female: 1/4" SAE 45°	CV11	Male: 5/16"SAE Female: 1/4"SAE 45°
CV06	Male: 1/4"SAE Female: 1/4" SAE 60°	CV12	Male: 5/16"SAE Female: 1/4" SAE 60°

Adapter

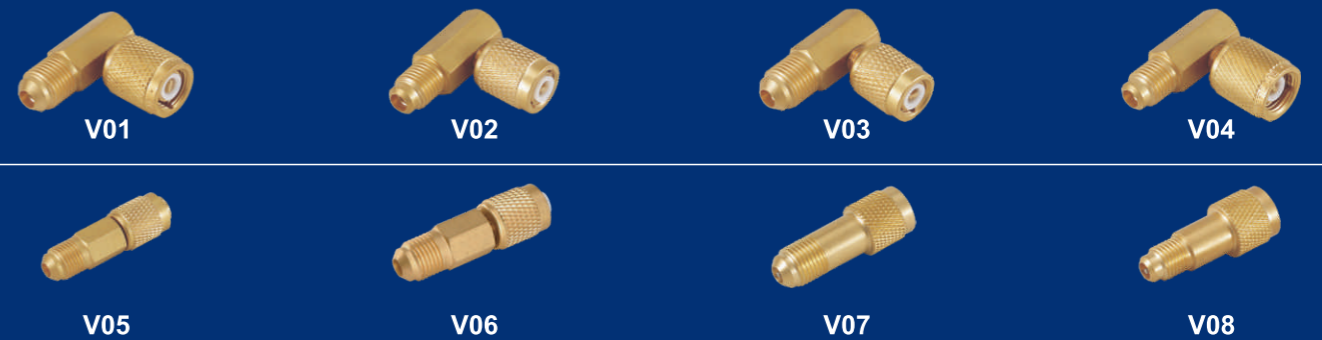

Item	Description	Item	Description
V01	Male: 5/16"SAE 90° Female: 5/16" SAE	V05	Male: 1/4"SAE Female: 5/16" SAE
V02	Male: 1/4"SAE 90° Female: 5/16" SAE	V06	Male: 5/16"SAE Female: 1/4" SAE
V03	Male: 5/16"SAE 90° Female: 1/4" SAE	V07	Male: 1/4"SAE Female: 5/16" SAE
V04	Male: 1/4"SAE 90° Female: 1/4" SAE	V08	Male: 5/16"SAE Female: 1/4" SAE

Refrigerant Scale



Refrigerant Scale



High Measurement

High Precise Sensor

- Precise measurement
- High precision

LCD Backlit Display

- Clear display, easy to read

Compact

- Easy to carry

Model	VES-50A	VES-100A
Weighting range	50 kg	100 kg
Resolution	2 g	5 g
Accuracy	±0.05% F.S	
Display	LCD	
Power	DC 9V	
Working environment	-10°C~40°C, ≤75% Humidity	
Platform size	237×237 mm	
Weight	5 kg	

High Measurement

High Precise Sensor

- Precise measurement
- High precision

LCD Backlit Display

- Clear display, easy to read

High Precise Valve

- Quantitative filling precision control

Compact

- Easy to carry

Model	VES-50B	VES-100B
Weighting range	50 kg	100 kg
Resolution	2 g	5 g
Accuracy	± 0.05% F.S	
Display	LCD	
Power	DC 9V/AC(100V~230V)	
Working environment	-10°C~40°C, ≤75% Humidity	
Platform size	237×237 mm	
Weight	6.5 kg	
Automatic shut-off	Yes	

Pipe Tools / HVAC Instrument

Easy

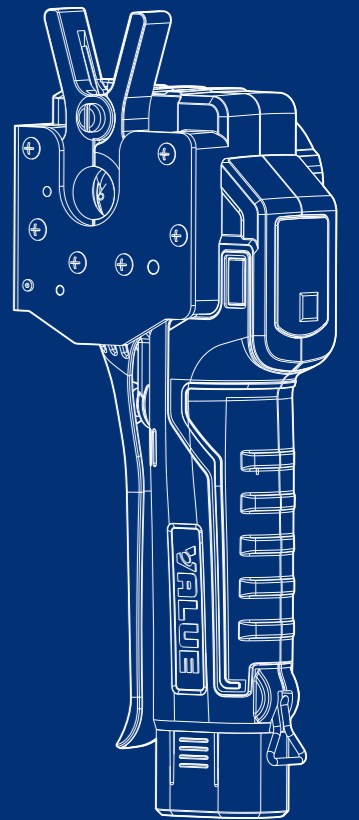

VET-19Li

Redefine Easy Flaring

Comprehensive Upgrade · New Experience

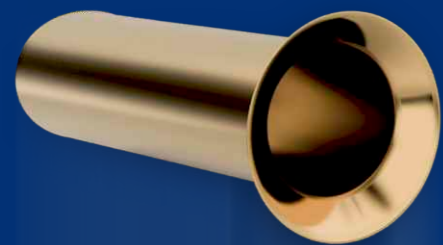

VET-19Li

Cordless Flaring Tool



7.4V 2.0Ah
LITHIUM

Quick Accurate Flaring

Easy Flaring

- Lithium-driven
- One-key operation, and high efficiency

45° Eccentric Design

- Point contact reaming, accurate flaring

Innovative Clamp

- Quick assembling
- Accurate positioning, perfect flaring

Comfortable Handle

- Compact structure, only 1.3 kg
- Comfortable and effortless grip

Long Battery Endurance

- 2000 mAh Li-Battery Available for 90 times (3/8")
- 50W rapid charging, only 35 min for fully charge

Model	VET-19Li
Battery	7.4V Li-battery
Applicable Pipe	Copper pipe
Tubing O.D.	1/4", 3/8", 1/2", 5/8" (16 mm), 3/4" (19 mm) Options (6 mm, 10 mm, 12 mm)
Dimensions	252x101x100mm
Weight	1.3 kg

Hand or Drill-Powered Flaring Tool

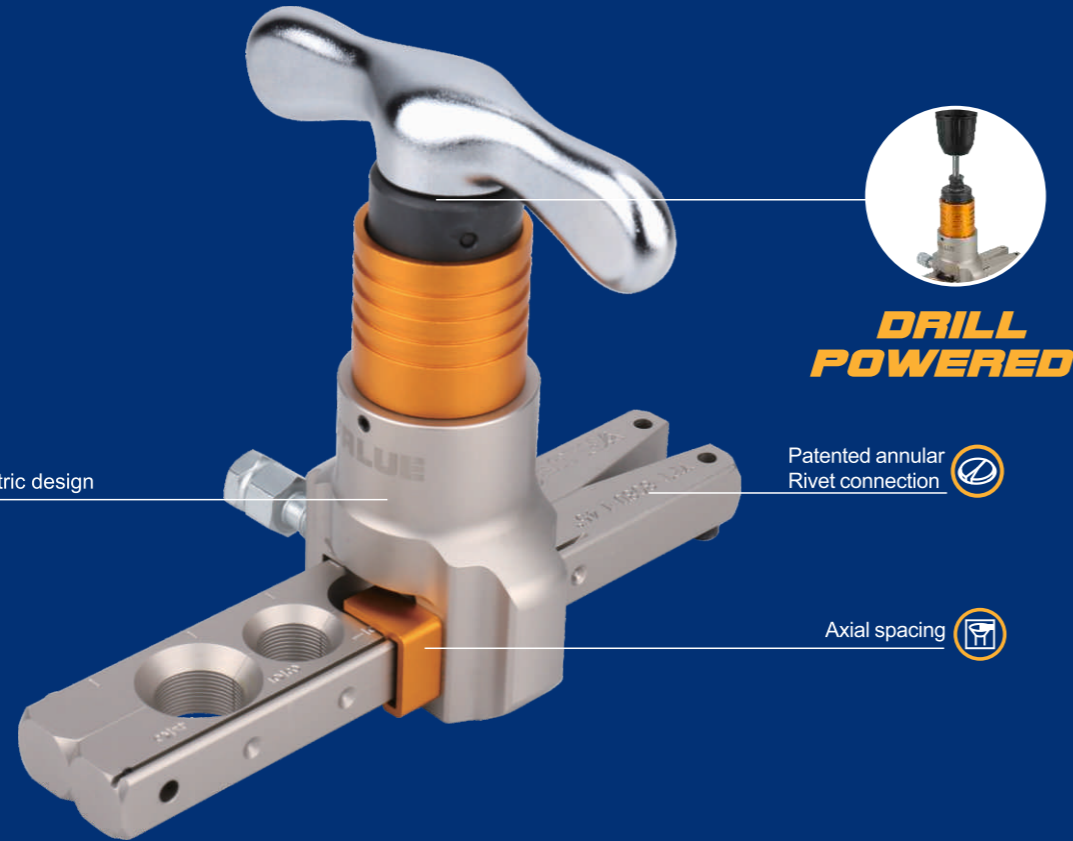

Accurate Flaring

Hand or Drill-Powered

- Easy to use

Axial Spacing

- Accurate and consistent flaring

Annular Rivet Connection

- Precise of flared

Lightweight

- Lightweight Aluminum Body

45° Eccentric design

- Point contact flare, dimension standard, easy to use

Model	Tubing O.D.	Accessory	Packaging
VFT-808E-I	1/4", 5/16", 3/8", 1/2", 5/8", 3/4"	/	Blow case
VFT-808E-MI	6, 8, 10, 12, 16, 19 mm 1/4", 5/16", 3/8", 1/2", 5/8", 3/4"	/	Blow case
VFT-808E-IS	1/4", 5/16", 3/8", 1/2", 5/8", 3/4"	VTC-32, VTT-5	Blow case
VFT-808E-MIS	6, 8, 10, 12, 16, 19 mm 1/4", 5/16", 3/8", 1/2", 5/8", 3/4"	VTC-32, VTT-5	Blow case

Flaring Tool



Usage method of quick-clamp

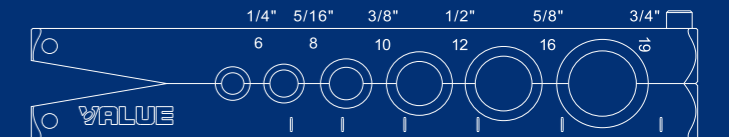

Accurate Flaring

Annular Rivet Connection

- Precise of flared

45° Eccentric design

- Point contact flare, standard dimension, easy to use

Model	Tubing O.D.	Accessory	Packaging
VFT-808-IN	1/4", 5/16", 3/8", 1/2", 5/8", 3/4"	/	Blister packing
VFT-808-I	1/4", 5/16", 3/8", 1/2", 5/8", 3/4"	/	Blow case
VFT-808-I-02	1/4", 5/16", 3/8", 1/2", 5/8", 3/4"	/	Carton
VFT-808-MI	6, 8, 10, 12, 16, 19 mm 1/4", 5/16", 3/8", 1/2", 5/8", 3/4"	/	Blow case
VFT-808-IS	1/4", 5/16", 3/8", 1/2", 5/8", 3/4"	VTC-32	Blow case
VFT-808-MIS	6, 8, 10, 12, 16, 19 mm 1/4", 5/16", 3/8", 1/2", 5/8", 3/4"	VTC-32	Blow case

Flaring Tool

Special design for R410A system



Precise positioning



45° Eccentric design

Patented annular Rivet connection

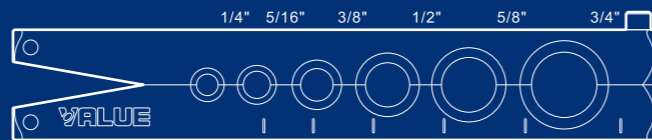

Accurate Flaring

Annular Rivet Connection

- Precise of flared

45° Eccentric design

- Point contact flare, dimension standard, easy to use

Model	Tubing O.D.	Accessory	Packaging
VFT-809-I	1/4", 5/16", 3/8", 1/2", 5/8", 3/4"	/	Blow case
VFT-809-IS	1/4", 5/16", 3/8", 1/2", 5/8", 3/4"	VTC-32	Blow case

The Outstanding Advantage of VALUE's Flaring Tool

Annular rivet connection



FAQ of copper pipe	Reason	Solutions	Result of flaring
Uneven bell mouth dimensions falls short, and cannot be normally used	Traditional flaring bar Large space between up and down clamps Excessive gap of flaring bar	Annular rivet connection Annular rivet connection makes left and right flaring bar, and will never dislocate Small space between left and right bar	Even and smooth orifice, accurate dimensions

45° Eccentricity

45° eccentricity, point contact reaming, standard dimensions, more convenient to use

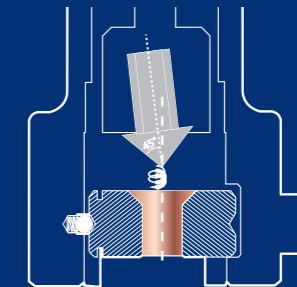

Precise Placing

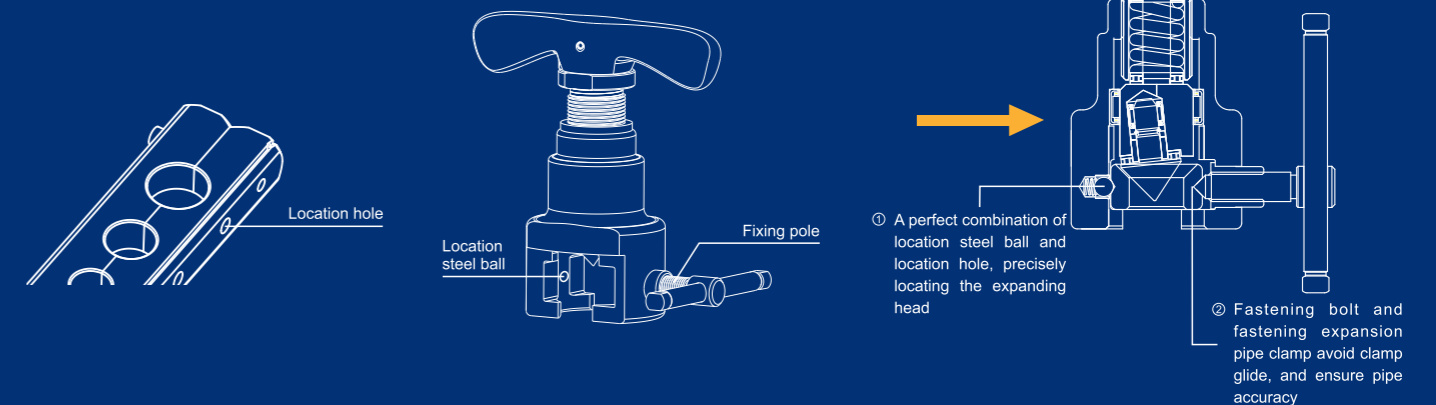

VTB-22L Power Tube Bender

It is a tough and frustrating job for HVAC Service Techs when bending large diameter tubes, which consumes tremendous labor work while needs precise focus on bending angles. Furthermore, to get the tube out of a traditional bender mandrel is another frustrating moment. Suitable for tubing sizing 1/4" to 7/8" OD, VALUE VTB-22L saves tons of your time and labor, and makes the job much easier. By pressing a single controller switch, you can bend the tube to any desired angle. When a bend is completed, the baffle will push the tube out automatically while tool resets, helping you to remove the tube effortlessly. Its large capacity lithium battery makes around 90 bends each charge and can be fully charged in 35 minutes. Reverse bending kit VTBRK is available and sold separately.

Leading Technology, Superior quality, Best Experience

Making Your Job More Enjoyable



VTB-22L Power Tube Bender

NEW



7.2V
LITHIUM **2.0** Ah

Industry's First Power Tube Bender

Battery-Driven Effortless Bending

- Powerful for large size tubing
- Push and hold for 90° bending
- Automatic tube release

Large Lithium Battery

- Around 90 bends per charge
- Quick charge in 35 minutes

Patented Tubing Size Selector

- 7 sizes in one selector
- Easy to switch to different tubing size setting

Other Features

- Quick connect mandrel and crossbar
- Battery power indicator

Easy Operation

- Ergonomic handle design
- Stop any time for customized angles

Model	VTB-22L
Battery Type	7.2V 2Ah 14.4Wh
Tubing Type	Soft (HVACR) Copper
Tube OD	1/4"(6mm), 5/16"(8mm), 3/8"(10mm), 1/2"(12mm), 5/8"(16mm), 3/4"(19mm), 7/8"(22mm)
Weight	2.8 kg (with battery)
Accessory	Carry Case

Bending Tool

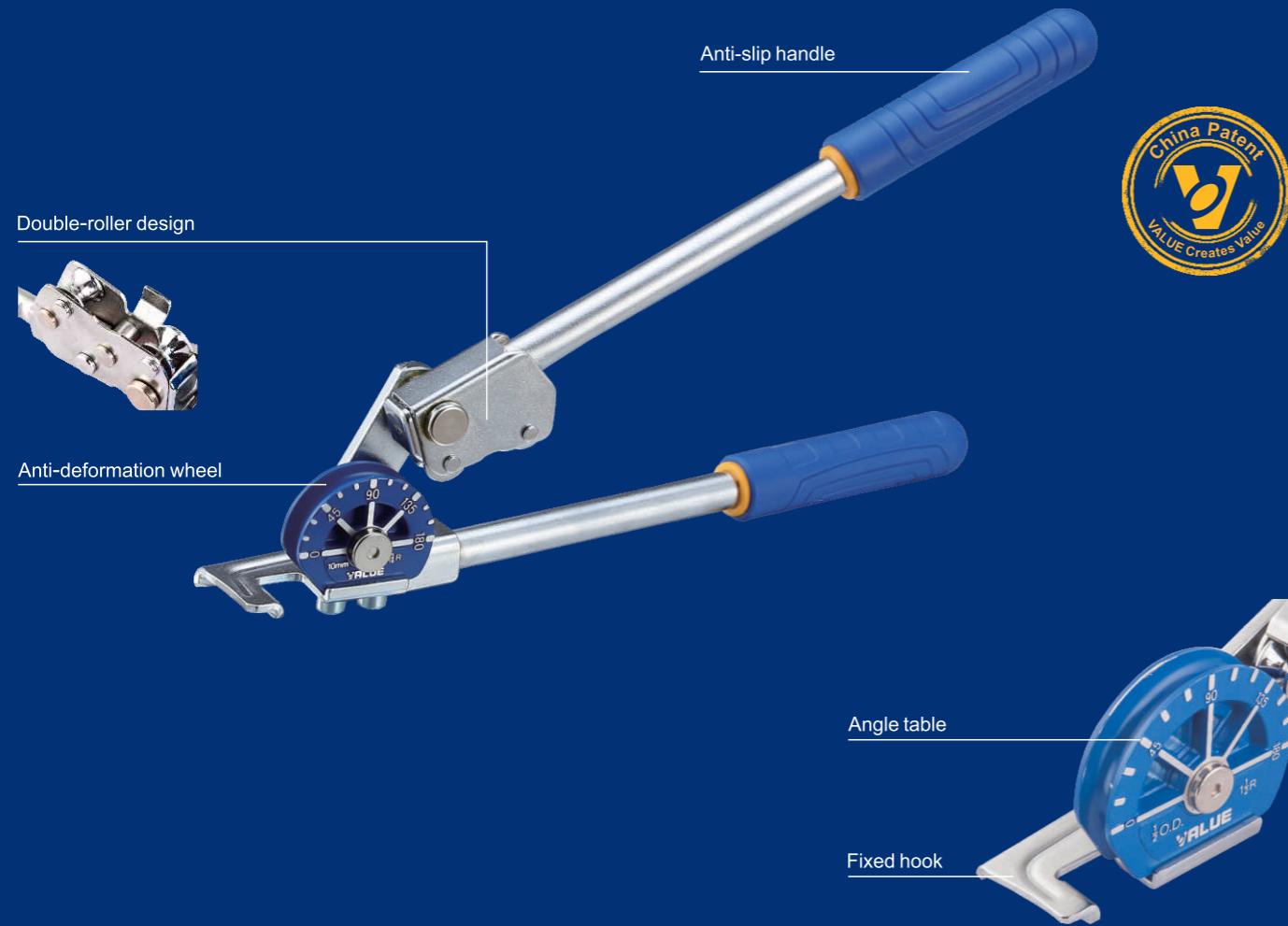

Easy to Bend

Double-roller

- Unique X-TURN steering structure
It's easier to bend on 90°
- Double-roller, reducing the pipe's friction, easy to bend

Angle Table

- The angle of bending is clearly visible

Anti-slip Handle

- Easy to use

VBT-1/2 Bending Tool

Model	VBT-1	VBT-1A	VBT-2	VBT-2A
Bending Size	3/8"	10 mm	1/2"	12 mm
Bending Radius	15/16"	15/16"	1-1/2"	1-1/2"
Bending Angle	0 ~ 180°			
Applicable Material	All soft pipes, thin-wall copper pipes and annealed treated hard pipe			

Bending Tool

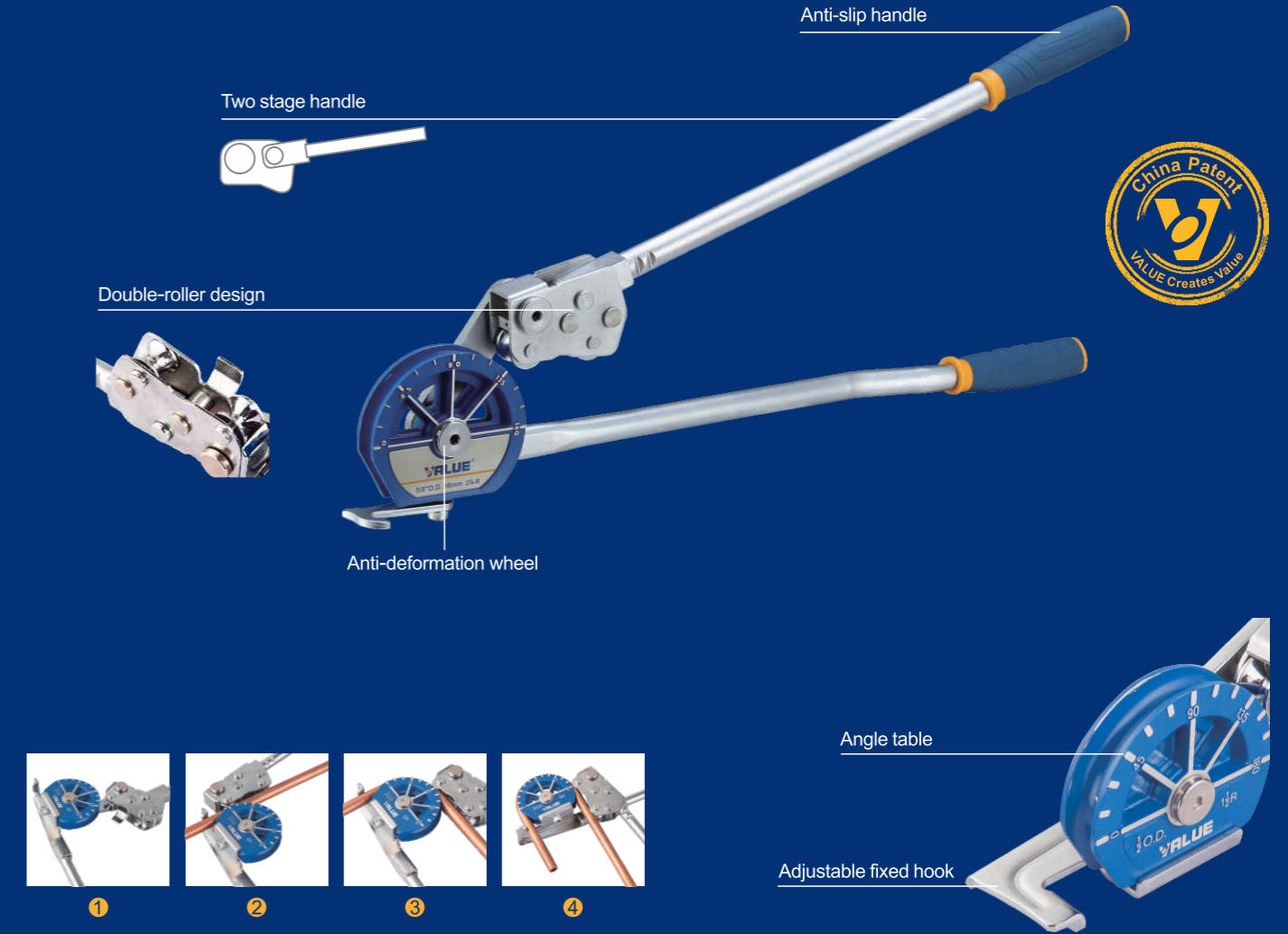

Easy to Bend

Double-roller

- Unique X-TURN steering structure
It's easier to bend on 90°
- Double-roller, reducing the pipe's friction, easy to bend

Two Stage Handle

- Easy to bend, larger angle of bending

Angle Table

- The angle of bending is clearly visible

Anti-slip handle

- Easy to use

VBT-3/4/5 Bending Tool

Model	VBT-3	VBT-4	VBT-5
Bending Size	5/8", 16 mm	3/4", 19 mm	7/8", 22 mm
Bending Radius	2-1/4"	3"	3-1/4"
Bending Angle	0 ~ 180°		
Applicable Material	All soft pipes, thin-wall copper pipes and annealed treated hard pipe		

Power Tube Expander



Effortless, Quick & Accurate Expanding

- One-button operation
- Automatic pressure relief
- Quick connect heads
- Large capacity lithium battery
- Complete an expansion in 10 seconds
- Up to 220 expansions per charge
- Quick charge in 35 minutes
- Innovative head design minimizing 3/8" tube splitting
- Battery power indicator
- LED flash light

Model	VTE-29D	VTE-42D
Battery	7.4V Li-battery	7.4V Li-battery
Applicable Pipe	Copper pipe	Copper pipe
Tubing O.D.	3/8", 1/2", 5/8", 3/4", 7/8", 1", 1-1/8"	3/8", 1/2", 5/8", 3/4", 7/8", 1", 1-1/8" 1-1/4", 1-3/8", 1-1/2", 1-5/8"
Dimensions	209x67x249 mm	209x67x249 mm
Weight	1.5 kg	1.5 kg

Hydraulic Tube Expander

NEW



Easy To Expand

Hydraulic Expander

- One hand operation
- Suitable for larger diameter copper

Compact

- Convenient for narrow spaces
- Easy to use

Automatic pressure relief

Quick connect heads

- Patented expander head, 180° quick locking

Model	Tube O.D.	Accessory
VHE-29D	3/8", 1/2", 5/8", 3/4", 7/8", 1", 1-1/8"	VTT-5 VTC-32
VHE-29DM	10, 12, 15, 16, 18, 22, 28 mm	VTT-5 VTC-32
VHE-29E	3/8", 1/2", 5/8", 3/4", 7/8", 1", 1-1/8"	/
VHE-29EM	10, 12, 15, 16, 18, 22, 28 mm	/
VHE-42E	3/8", 1/2", 5/8", 3/4", 7/8", 1", 1-1/8", 1-1/4", 1-3/8", 1-1/2", 1-5/8"	/
VHE-42EM	10, 12, 15, 16, 18, 22, 28, 35, 42 mm	/

Tube Expander



Anti-slip Handle

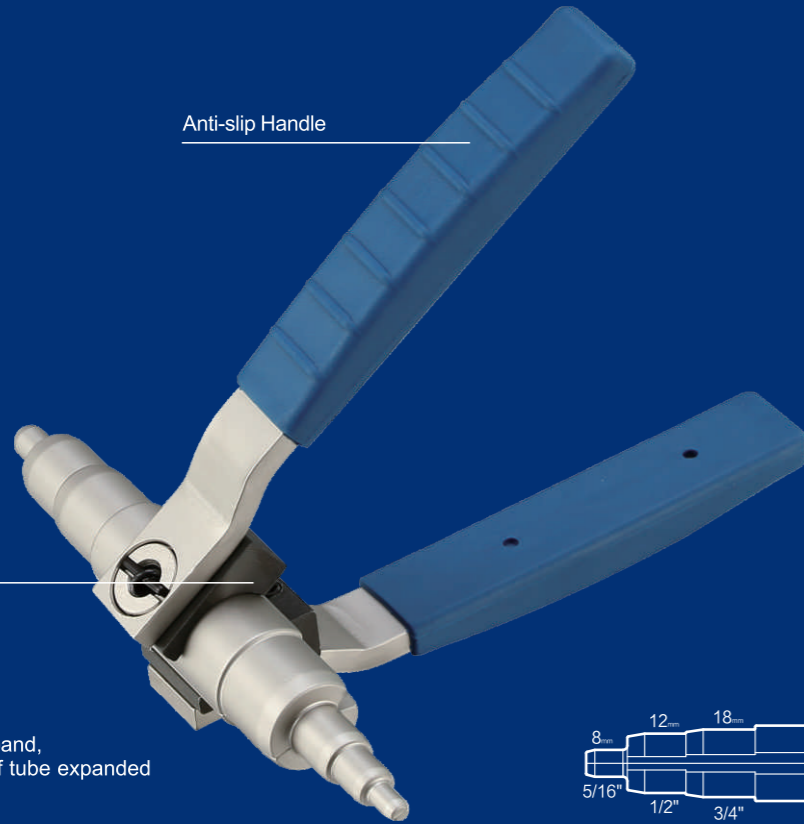

Foldable, easy to carry

Spacing groove



Prevent excessive expand,
Ensure the accurate of tube expanded

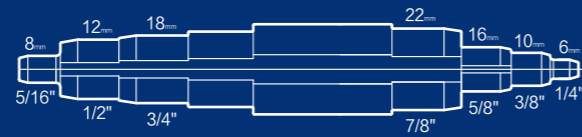

1 2 3 4 5

Easy to Expand

Easy to Use

- Simple structure for expanding copper tubing

Anti-slip handle

- Easy to use

Easy to Carry

- Foldable design for portability

Spacing Groove

- To prevent over flared, ensure the accurate of tube flared

Model	VST-22	VST-22B
Tube O.D.	3/8", 1/2", 5/8", 3/4", 7/8" 10, 12, 16, 18, 22 mm	1/4", 5/16", 3/8", 1/2", 5/8", 3/4", 7/8" 6, 8, 10, 12, 16, 18, 22 mm

Tube Cutter



Aluminum Alloy



Cutting Blade

Ball Bearings

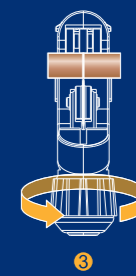

1

2

3

4

Easy to Cut

High-Quality Cutting Blade

- Sharp and durable

Ball Bearing

- Easy cutting and better quality

Aluminum Alloy

- Light weight, easy to carry and use

Model	VTC-19	VTC-32	VTC-35	VTC-42	VTC-70
Tube O.D.	1/8"~3/4" 3~19 mm	1/8"~1-1/4" 4~32 mm	1/8"~1-3/8" 4~35 mm	1/4"~1-5/8" 6~42 mm	1/4"~2-5/8" 6~67 mm

VTT-5 Tube Deburring

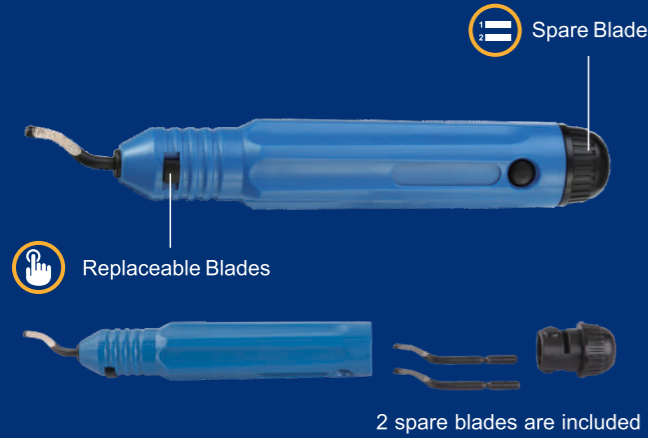

Easy to Deburr

Compact Design

- Easy to carry

Spare Blade

- 2 spare blades are included

Replaceable Blades

- Easy to change blade

VRT-201/202 Ratchet Spanner



Easy to Rotary

Ratchet

- Advanced ratchet, leave out the tedious transformation steps, easy to use, and easy to rotary

Anti-slip Handle

- Power holding, anti-slip, easy to rotary

VRT-101 Capillary Tube Plier



Easy to Shear

Sharp Blade

- Excellent stainless steel blade, easy to shear capillary

Spacing Spring

- Easy to use

Anti-slip Handle

- Power holding, anti-slip, easy to shear

VRT-301 Deburring Tool

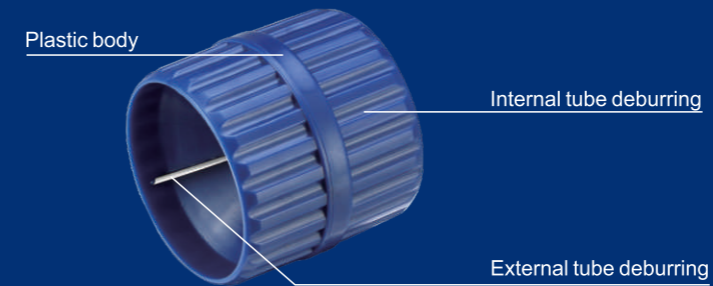

Easy to Deburr

Multi-blade Alloy Steel Internal Surface

- Easy to deburring

Slip-resistant Aluminum Body Design

- Light weight

Tube O.D.: 4-40 mm ($1/8''$ - $1-5/8''$)



VRT-102 Sealing Pliers



Easy to Seal

Inactivate Jaw

- Power clamp force, it can seal copper pipe quickly

Force Adjusting Nut

- Easy to adjust clamp force

Ergonomic Design Handle

- Anti-slip design, easy to use

VRT-302 Internal & External Reamer

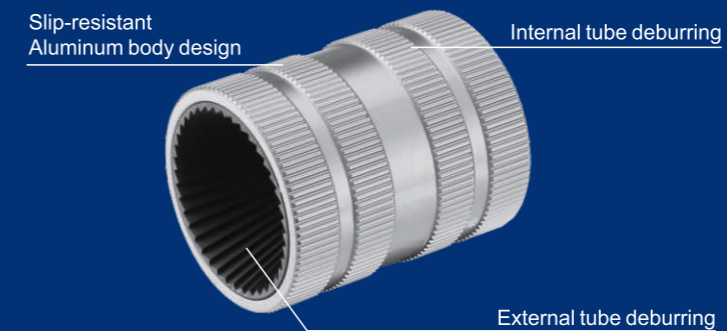

Easy to Deburr

Multi-blade Alloy Steel Internal Surface

- Easy to deburring

Slip-resistant Aluminum Body Design

- Light weight

Tube O.D.: 8-35 mm ($1/3''$ - $1-2/5''$)



VTB-5A Tool Kit



Easy to Carry

Easy to Carry

- Aluminum alloy toolbox, easy to carry

Protect Tools

- Aluminum alloy toolbox, better protection tools during transportation

Complete With	Description	Quantity
Vacuum Pump	1.5CFM	1pc
Flaring Tool	VFT-808-I	1set
Tube Cutter	VTC-32	1pc
Tube Deburring	VTT-5	1pc
Manifold Gauge	VMG-2-R410A	1set
Tube Expanders	VST-22	1pc
Package	Aluminum alloy box	1pc

Tool Kit



Easy to Carry

Easy to Carry

- Blow molding toolbox, easy to carry

Easy to Use

- Include cutter, tube expander, manifold, refrigerant hose

Model	VTB-5B-I		VTB-5B-II		VTB-5B-III	
	Description	Quantity	Description	Quantity	Description	Quantity
Complete With						
Flaring Tool	VFT-808-I	1set	VFT-808-I	1set	VFT-808-I	1set
Tube Cutter	VTC-32	1pc	VTC-32	1pc	VTC-32	1pc
	VTC-19	1pc	VTC-19	1pc	VTC-19	1pc
Manifold Gauge	VMG-2-R410A	1set	VMG-2-R410A	1set	VMG-2-R410A	1set
Tube Deburring	VTT-5	1pc	VTT-5	1pc	VTT-5	1pc
Adapter	/	/	V01 V08	1set	V01 V08	1set
Adapter	/	/	/	/	CV01-CV12	1set
Package	Blow case	1pc	Blow box	1pc	Blow box	1pc

HVAC instrument

Accurate

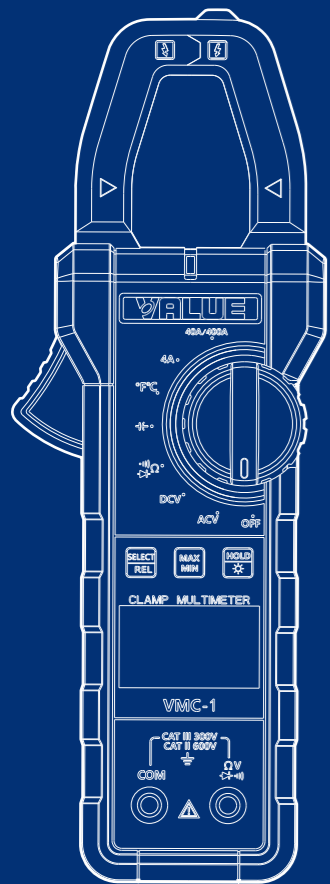

VMC-1

Digital Clamp Multimeters

Clamp VMC-1, design of high precise smart chip, It can accurately measure the change of small current; 28mm jaw, it's specially designed for you to repair an unexpected wire and circuit detection; compact design, better experience, it's easy to use.



Precise Measurement

High precision chip

- Precise measurement

LCD backlit display

- Large screen data display, better readability

28mm jaw

- Suitable for more demanding circuit maintenance

Compact design

- Easy to carry

Model	VMC-1
Max Measurement Voltage	600V
Max Measurement AC Current	400 A
Max Measurement Capacitance	4 mF
Temperature Measurement Range	-40°C~1000°C

VIT-300S

Infrared Thermometer

VALUE VIT-300S non-contact infrared thermometer can help determine the surface temperature by measuring the infrared energy of the target surface. The design of low power consumption makes the product serve a longer period, reducing the frequency of battery change for users. In addition, the high precision infrared sensor can help users quickly and accurately finish measurement.

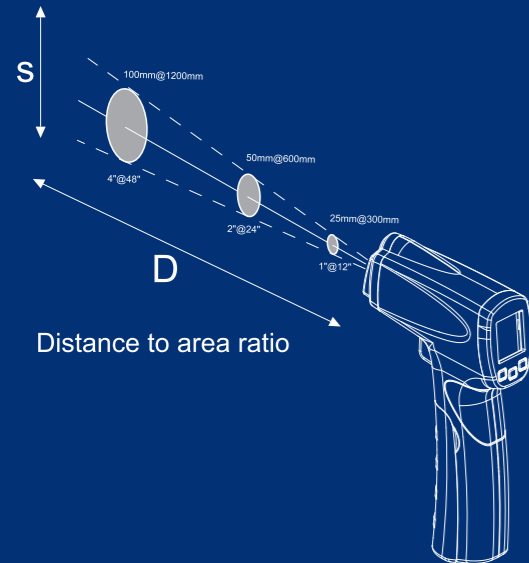

LCD Backlit Display

Precise Measurement

Precision Infrared Sensor

- Accurate measurement, respond faster

Large-aperture Silicon Mirror

- Measures long distance
- Wide measuring range

One-key Temperature Measurement

- Easy to use, convenient

LCD Backlit Display

- Clear display, easy to read

Model	VIT-300S
Emissivity	0.10~1.00 adjustable
Temperature Range	-32°C~400 °C (-25.6°F~752 °F)
Max Measuring Accuracy	±2°C or ±2%
Response Time	500 mS
Debug Mode	Single-process debugging

VMV-1

Vacuum Gauge

It uses the Pirani high-precision vacuum sensor to precisely measure vacuum levels. Digital display affords a comprehensive view of vacuum conditions. When reaching the preset vacuum level, it will buzz as a reminder. When the vacuum level decreases from the pre-set vacuum level, it will buzz rapidly and flash the backlight to warn of leaks.



Large Backlight Display

Buzzing Remind

High-precision Vacuum Sensor

Precise Measurement

Ergonomic Design

- Easy to carry

Precision Vacuum Sensor

- Pirani sensor

Large Backlit Display

- Easy-to-read large digital display
- Backlit display for clarity

Buzzing Alert

- Vacuum level reminder
- Vacuum leakage warning

Model	VMV-1
Maximum overload pressure	72 PSI/0.5 Mpa
Range	0~10000 Pa, 0~100.00 mBar, 0~75.000 mmHg, 0~75000 Microns
Resolution	0.01(< 10 Pa), 0.0001(< 10 mBar), 0.0001(< 10 mmHg), 1(< 30000 Microns)
Accuracy	2~100Pa : ±5% of reading(at 20 °C)
Operating temperature	0~50 °C
Unit	Pa, mBar, mmHg, Microns
sensor	Pirani sensor
Dimensions	147x59x33 mm
Weight	Only 125 g

VMS-1 Sound Level Meter

Sound Level Meter VMS-1, with micro capacitor-type microphone sensing technology and bandwidth weighting network design, to enable small interference on the sound field, fast response and a precise, efficient noise measurement.



VMA-1 Anemometer

Anemometer VMA-1, with magnetic sensor technology and precision computing amplifier chip, enable to directly convert the airflow rate into electrical signals; through the microprocessor chip to process data, using the electronic digital display to provide you with accurate measurements. It resolved the issues with traditional anemometer such as large volume and initial high airspeed, so as to achieve precision measurement.

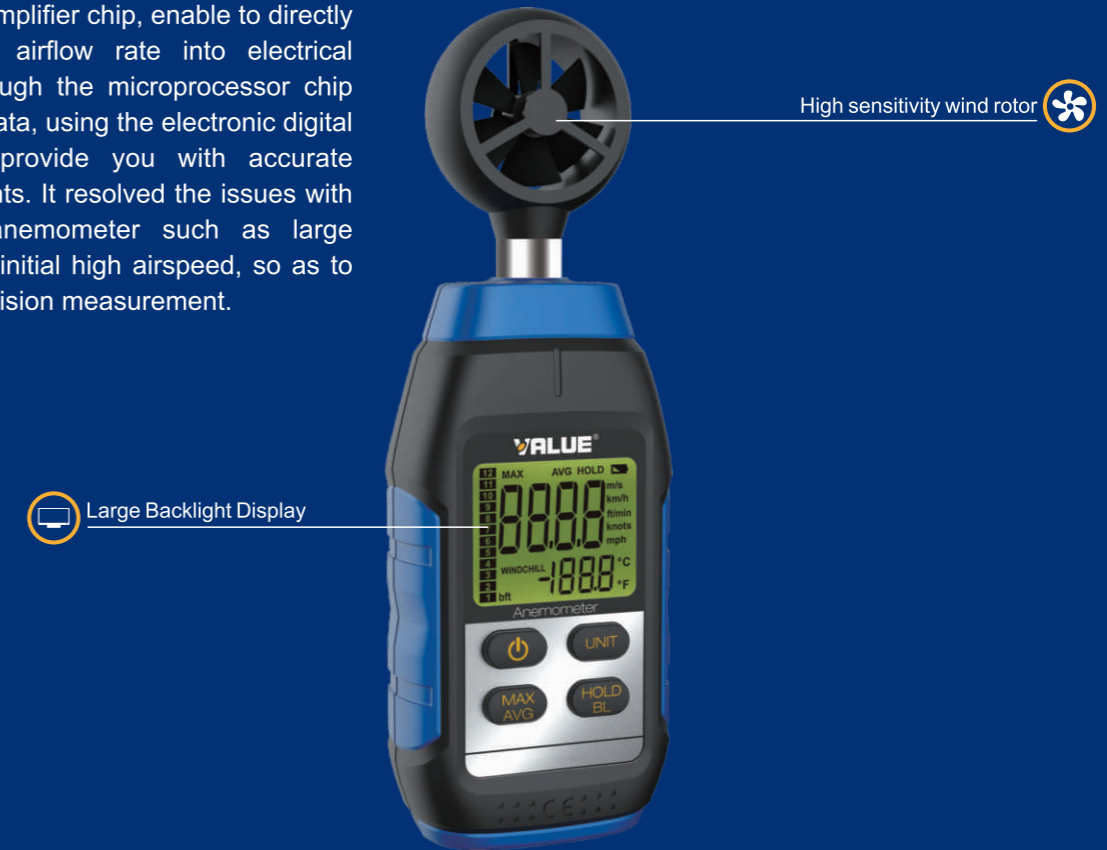

Precise Measurement

Ergonomic Design

- Easy to carry

Micro Capacitor-type Microphone Sensing Technology And Bandwidth Weighting Network Design

- Fast response
- Accurate and Efficient

Large Backlit Display

- Easy-to-read large digital display
- Backlit display for clarity

Model	VMS-1
Noise measurement scope	30~130 dB
Accuracy	±1.5 dB
Refresh rate	31.5Hz~8kHz
Resolution	0.1 dB
Sampling rate	Fast: 125ms / Slow: 1000ms
Power	1.5V AAx3
LCD size	32x26 mm
Dimensions	155x57x35 mm
Weight	Only 88g

Precise Measurement

Ergonomic Design

- Easy to carry

High Sensitivity Wind Rotor

- 6 vanes high sensitivity wind rotor
- Low friction bearing technology

Large Backlit Display

- Easy-to-read large digital display
- Backlit display for clarity

Model	VMA-1
Wind Speed Measurement Scope	0~12
Accuracy of wind-speed measurement	± (5%rdg+0.5)
Accuracy of temperature measurement	±2 °C
Wind Scale Accuracy	±1
Wind-speed resolution	0.1 m/s
Temperature resolution	0.1 °C
Sampling rate	500 ms
Power	1.5V AAx3
LCD size	32x26 mm
Dimensions	164x57x30 mm
Weight	95 g

M1/M2

Condensate Pump



Electrode water level sensor

Ultra-Quiet, Reliable

Ultra-Quier DC motor

- Quiet operation

Electrode water level sensor

Easy Maintenance

- Snap-on stucture, easy disassembling and cleaning of water tank

Water Pipe Isolates from PCB

- Anti-leakage & Anti-short circuit

LED flash light

- Effectively monitor product running condition

Large Capacity Tank

- Reducing work times and extending life

Model	M1	M2
Voltage	100-240V/50-60Hz	100-240V/50-60Hz
Discharge head (Max.)	12m / 39ft	12m / 39ft
Flow rate (Max.)	24L/h 6.4 US GPH	40L/h 10.6 US GPH
Effective water tank capacity	200ml	200ml
Unit output (Max.)	9kW 30000btu/h	13kW 45000btu/h
Noise at 1m	19dB(A)	21dB(A)
Applicable ambient temperature	0°C-50°C	0°C-50°C

S1/S2

Mini Condensate Pump



Electrode water level sensor

Ultra-Quiet, Reliable

Ultra-Quier DC motor

- Quiet operation

Built-in Filter

- Effectively filter impurities and prevent blockage

Water Pipe Isolates from PCB

- Anti-leakage & Anti-short circuit

Mini Design

Model	S1	S2
Voltage	100-240V/50-60Hz	100-240V/50-60Hz
Discharge head (Max.)	10m / 33ft	10m / 33ft
Flow rate (Max.)	24L/h 6.4 US GPH	40L/h 10.6 US GPH
Effective water tank capacity	50ml	50ml
Unit output (Max.)	9kW 30000btu/h	13kW 45000btu/h
Noise at 1m	19dB(A)	21dB(A)
Applicable ambient temperature	0°C-50°C	0°C-50°C

NAVTEK™ High-end Series
Ushering in the smart era of HVAC tools

Making Your Job More Enjoyable
Leading Technology, Superior Quality, Best Experience

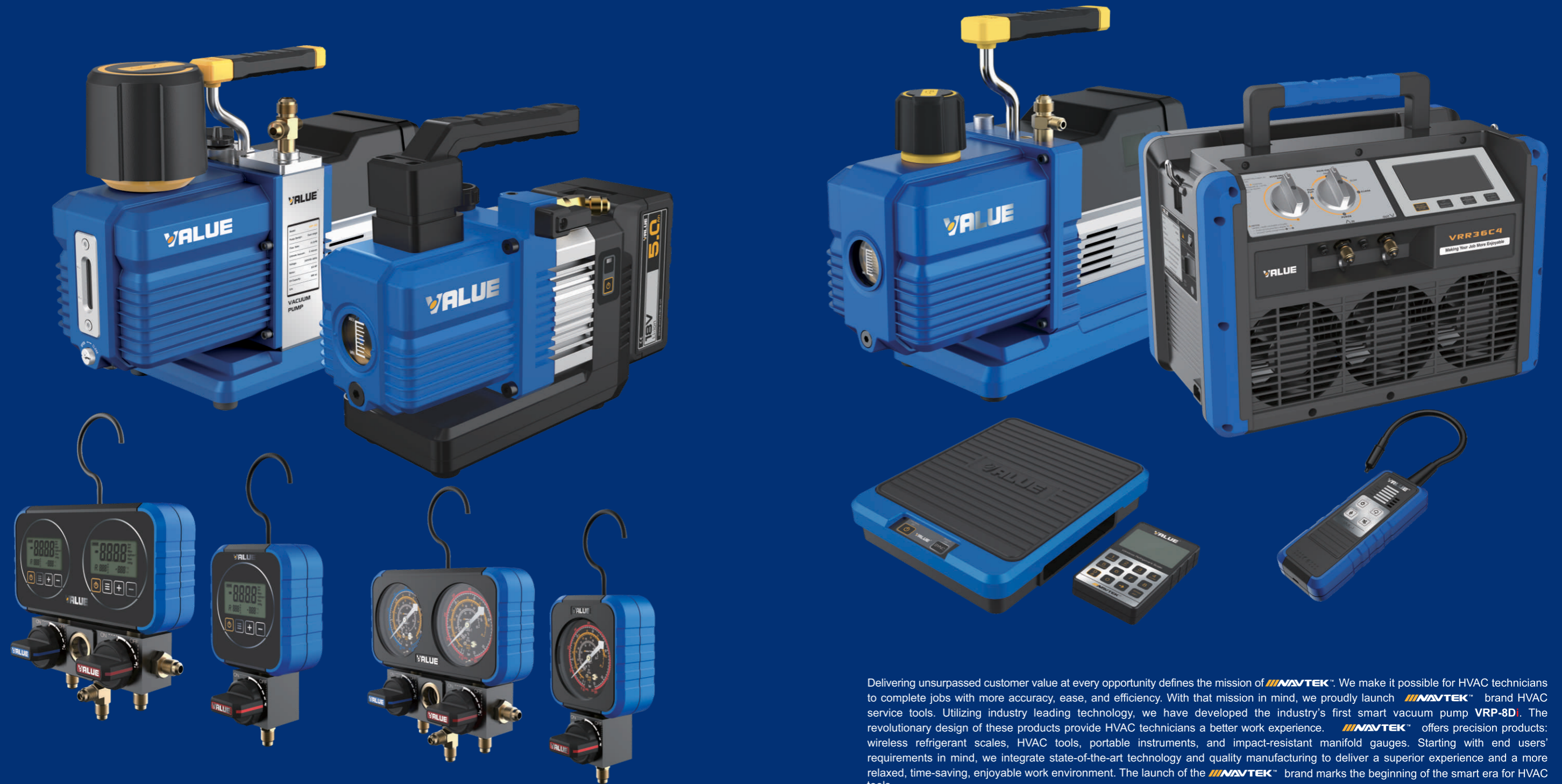

Delivering unsurpassed customer value at every opportunity defines the mission of **NAVTEK™**. We make it possible for HVAC technicians to complete jobs with more accuracy, ease, and efficiency. With that mission in mind, we proudly launch **NAVTEK™** brand HVAC service tools. Utilizing industry leading technology, we have developed the industry's first smart vacuum pump **VRP-8D1**. The revolutionary design of these products provide HVAC technicians a better work experience. **NAVTEK™** offers precision products: wireless refrigerant scales, HVAC tools, portable instruments, and impact-resistant manifold gauges. Starting with end users' requirements in mind, we integrate state-of-the-art technology and quality manufacturing to deliver a superior experience and a more relaxed, time-saving, enjoyable work environment. The launch of the **NAVTEK™** brand marks the beginning of the smart era for HVAC tools.

Leading Technology, Superior Quality, Best Experience.

Making Your Job More Enjoyable

Suit for
R32

VALUE
VALUE Creates Value

Making Your Job More Enjoyable

Li-battery Vacuum Pump

Suit for R32, 1234yf

The cordless vacuum pump VRP-2D_{Li}, designed with high performance lithium batteries, is designed to allow constant vacuum pumping for 50 minutes; Lightweight design that enables the product to be carried to workplace very conveniently; Smart motor drives the product to achieve a faster vacuum pumping and higher ultimate vacuum with a lighter weight; At the same time, the product configured with the ball valve switch, it can be closed more easily after completing the vacuum pumping operation.

Leading Technology, Superior quality, Best Experience

Making Your Job More Enjoyable

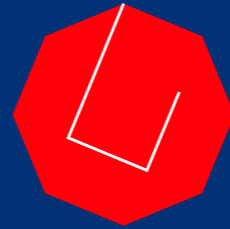

Contemporary **Good** Design



18V LITHIUM 5.0 Ah

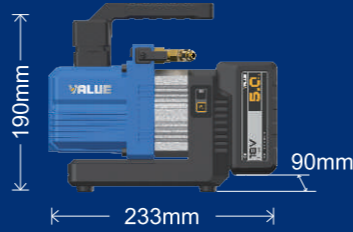

Easy-to-use & portable

Lithium-powered, Portable and Light

DC Motor

- Lighter weight, more powerful, Faster evacuation

High Performance Lithium Battery

- Dual Stage Running time reaches 50 minutes
- Single Stage Running time reaches 75 minutes

Mini Design

- Easy-to-use & portable

Ball Valve Switch

- Easy operation, better experience
- Easy-to-turn off

Big Sight Glass

- Easy-to-see
- Ensuring high-reliability operation

Model	VRP-2D _{Li}	VRP-2S _{Li}
Flow Rate	2.0 CFM	2.0 CFM
	57 L/min	57 L/min
Ultimate Vacuum	2 Pa	2 Pa
	23 micron	150 micron
Pump Design	Dual stage	Single stage
Inlet Port	1/4" SAE	1/4" SAE
Oil Capacity	160 ml	180 ml
Battery	18V 5Ah	18V 5Ah
Running time	50 min	75 min
Dimensions	233×90×190 mm	233×90×190 mm
Weight	3.2 kg	2.7 kg

Suit for
R32

VALUE
VALUE Creates Value

Making Your Job More Enjoyable

VRP-4D_{Li}

Li-battery Vacuum Pump

Suit for R32, 1234yf

MINI Mini Design

Dual Stage

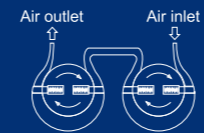

18V LITHIUM 9.0 Ah



Easy-to-use & portable

Lithium-powered, Portable and Light

DC Motor

- Lighter weight, more powerful, Faster evacuation

High Performance Lithium Battery

- Running time reaches 50 minutes

Mini Design

- Easy-to-use & portable

Ball Valve Switch

- Easy operation, better experience
- Easy-to-turn off

Big Sight Glass

- Easy-to-see
- Ensuring high-reliability operation

Model	VRP-4D _{Li}
Flow Rate	4.0 CFM 114 L/min
Ultimate Vacuum	2 Pa 15 micron
Pump Design	Double stage
Inlet Port	1/4" SAE & 3/8"
Oil Capacity	260 ml
Battery	18V 9Ah
Running time	50 min
Dimensions	320×112×242 mm
Weight	7 kg

Smart Vacuum Pump

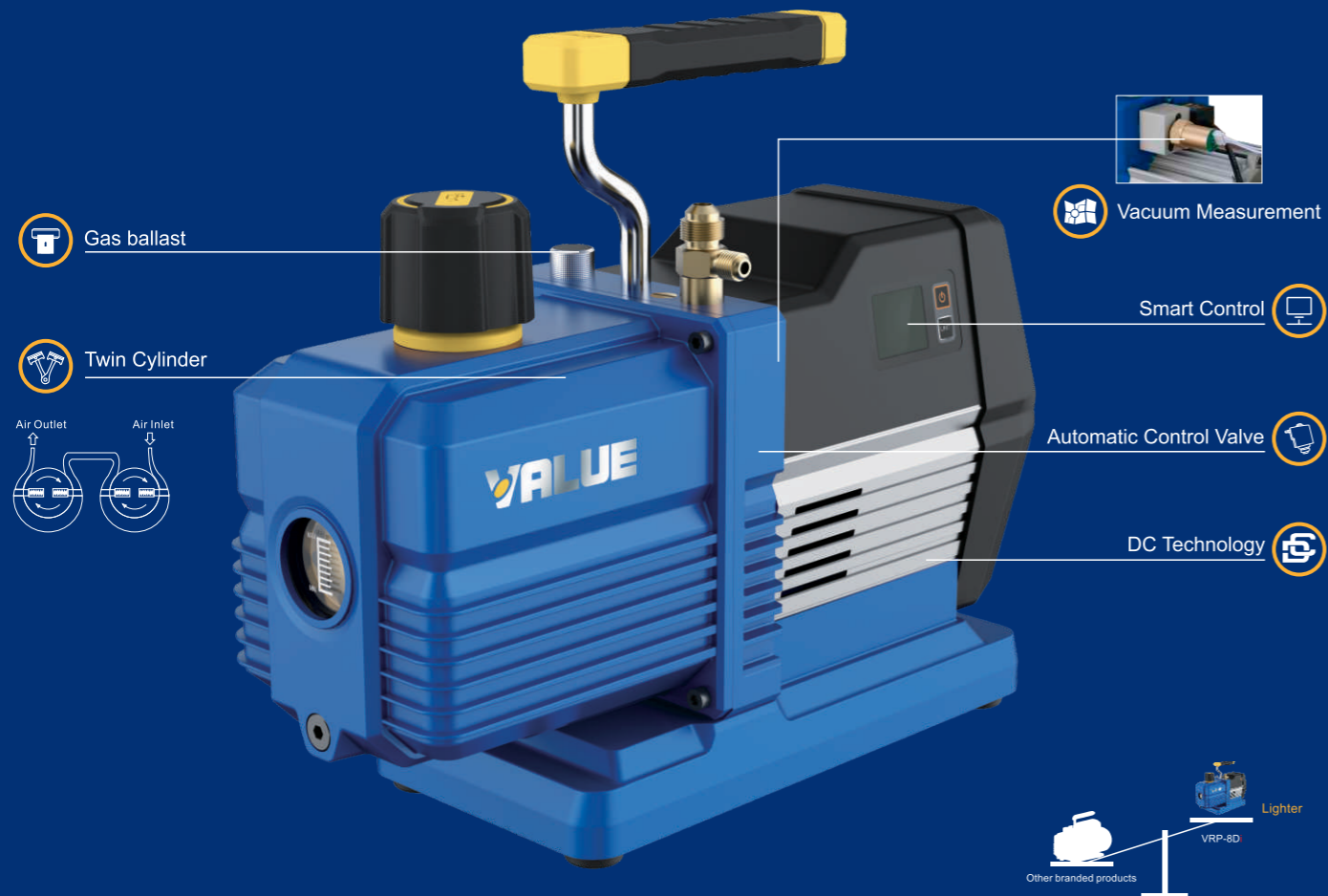

Smart Control Technology

DC Technology

- Lighter
- More efficient

Smart Control

- Extended evacuation for better vacuum
- Automatic control
- Task reminder

Vacuum Measurement Technology

- Precise micron measurement
- Vacuum display

Twin Cylinder

- Higher ultimate vacuum

Automatic Control Valve

- Prevent oil back flow
- Preserve vacuum

Model	VRP-6D	VRP-8D
Flow Rate	6.0 CFM 170 L/min	8.0 CFM 226 L/min
Ultimate Vacuum	15 micron 2x10 ⁻¹ Pa	15 micron 2x10 ⁻¹ Pa
Pump Design	Dual stage	Dual stage
Motor Power	3/4 HP	3/4 HP
Inlet Port	1/4" & 3/8" SAE	1/4" & 3/8" SAE
Oil Capacity	600 ml	600 ml
Dimensions	346×145×302 mm	346×145×302 mm
Weight	11.5 kg	11.5 kg

Suit for R32, 1234yf, R410A, R22, R134a refrigerant & etc.

Vacuum Pump

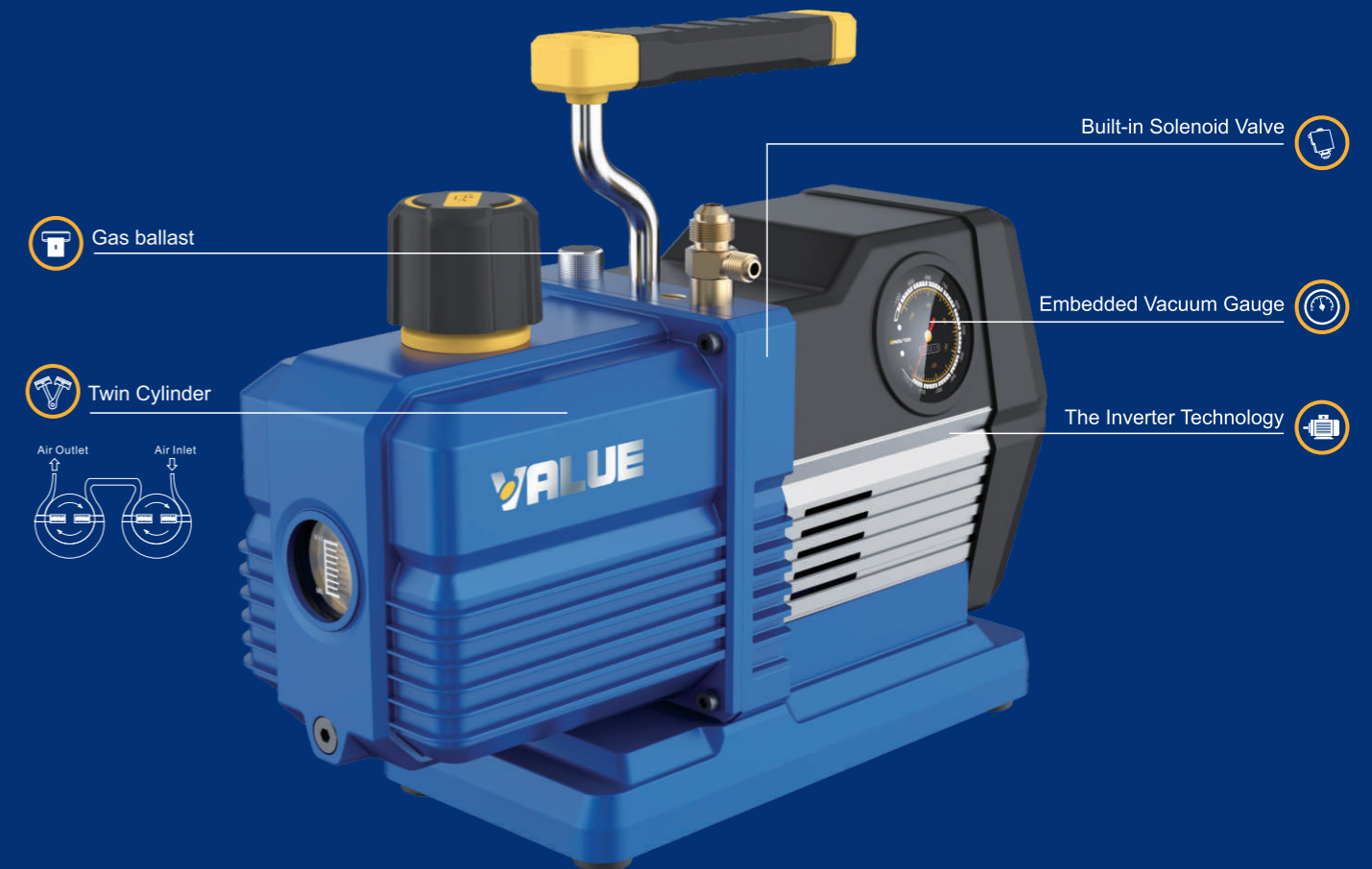

Accurate/Efficient

Built-in Solenoid Valve

- Preserve vacuum during power failure
- Prevent oil back flow

Embedded Vacuum Gauge

- Precision/Anti-Shock

DC Technology

- Lighter
- More efficient

Precision Manufacturing

- More reliable

Model	VRP-6DV	VRP-8DV
Flow Rate	6.0 CFM 170 L/min	8.0 CFM 226 L/min
Ultimate Vacuum	15 micron 2x10 ⁻¹ Pa	15 micron 2x10 ⁻¹ Pa
Pump Design	Dual stage	Dual stage
Motor Power	3/4 HP	3/4 HP
Inlet Port	1/4" & 3/8" SAE	1/4" & 3/8" SAE
Oil Capacity	600 ml	600 ml
Dimensions	346×145×302 mm	346×145×302 mm
Weight	11.5 kg	11.5 kg

Suit for R32, 1234yf, R410A, R22, R134a refrigerant & etc.

VRP-15D

Vacuum Pump

Double Speed, Super Vacuum Performance

Suitable for evacuation of large commercial refrigeration, central AC systems.

With industrial grade technology, VRP-15D solves the problems of long-time evacuation, inadequate vacuum level in the service for large commercial refrigeration or central AC systems. The dual stage rotary vane pump and inverter motor lead to faster evacuation and a deeper vacuum. Integrate pump cylinder and built-in oil back-flow prevention assure the superior performance and reliability. The combination of enhanced technology and aesthetic design enable the VRP-15D to be a top of class product.

Leading Technology, Superior Quality, Best Experience.

Making Your Job More Enjoyable



VRP-15D

Vacuum Pump



Twin Cylinder

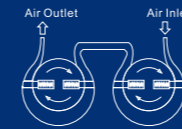

Oil Drain Valve

15CFM **5micron**

Anti-suckback Built-in automatic anti-suckback valve

Double Speed, Super Vacuum Performance

Industrial Grade Design

- High Quality, Super High Vacuum
- High Evacuation Performance

DC Motor

- Light, Fast

Integrated Dual Stage Pump

- High Vacuum Level

Oil Back Flow Prevention

- No system oil contamination during power failure

Oil Drain Valve

- Ball valve design, Easier to drain

Sight Glass

- Easy to see, Eliminate oil shortage

Model	VRP-15D
Flow Rate	15 CFM 425 L/min
Ultimate Vacuum	0.67 Pa 5 micron
Pump Design	Dual stage
Motor Power	3/4 HP
Inlet Port	1/4", 3/8", 1/2" SAE
Oil Capacity	880 ml
Dimensions	414×152×310 mm
Weight	15 kg

VRDDF Recovery Unit

Suitable for R290, R600a

VRDDF Recovery unit is suitable for Group IIA, Division 2, Group D T4. It is design reference to UL121201, CSA C22.2 No.213-17 and EN 60079-7 standards. VRDDF adopts secure starter, substantial security circuit to limit energy, the engine temperature limit, such as IP rating for elaborate design, suitable for A2L, A2, R290 R600a refrigerants.

Leading Technology, Superior Quality, Best Experience.

Making Your Job More Enjoyable



VRDDF Recovery Unit



Conform to ATEX



Sparkless Power Supply

Oil-Free Compressor

One Key Operation

Digital Display

Purge Function

Brushless DC Technology

Designed for R290, R600a

For HVAC application ONLY.
FORBID to use Group IIB, Group IIC refrigerant.

Designed for R290, R600a

- Design reference to UL 121201, CSA C22.2 No. 213 and EN 60079-7 Standards

Fast and Efficient Recovery

- Brushless DC motor
- Twin cylinder with 2-row oversized condenser

Large Backlit Display

- Easy-to-read large LCD display
- Backlit for clarity

Oil-Free Compressor

- Suitable for all commonly used refrigerants

Purge Function

- Prevent mixing of various refrigerants

IP54 Design

- Tested to be waterproof and dustproof

Model	VRDDF			
Refrigerant	Categories III: R12, R134a, R401C, R500, 1234yf, R600a Categories IV: R22, R401A, R401B, R402B, R407C, R407D, R408A, R409A, R411A, R411B, R412A, R502, R509, R290 Categories V : R402A, R404A, R407A, R407B, R410A, R507, R32, R507			
Power Supply	220-240V~50/60Hz	115V/60Hz		
Motor	Brushless DC motor 1HP			
Motor Speed	3000 rpm			
Maximal Current Draw	6.5 A	12 A		
Compressor	Oil-less, Air-cooled, Piston style			
Automatic Safety Shut-Off	38.5bar/3850kPa(558psi)			
Recovery Rate (kg/min)		Categories III	Categories IV	Categories V
	Vapor	0.43	0.54	0.54
	Liquid	3.60	4.00	4.20
	Push/Pull	7.50	8.50	9.50
Operating Temperature	0 °C-40 °C			
Dimensions	370×250×297 mm			
Weight	11 kg			

VRR36C4

Recovery Unit



4-Cylinder

Fastest · Most Powerful

4-Cylinder

- More powerful

Super-Efficient Condenser

- Over-sized micro-channel condenser
- 3 cooling fans

Brushless DC Motor

- More efficient

Large Digital Display

- Easy-to-read large LCD display
- Backlit for clarity

Dual Oil-Free Compressors

- Suitable for all commonly used refrigerants

Model	VRR36C4			
Refrigerant	Categorys III : R12, R134a, R401C, R500, 1234yf Categorys IV : R22, R401A, R401B, R402B, R407C, R407D, R408A, R409A, R411A, R411B, R412A, R502, R509 Categorys V : R402A, R404A, R407A, R407B, R410A, R507, R32			
Power Supply	220-240V~50/60Hz	115V~50/60Hz		
Motor	Brushless DC motor 1.5HP			
Motor Speed	3000 rpm			
Maximal Current Draw	8.5 A	12 A		
Compressor	Oil-less, Air-cooled, Piston style			
Automatic Safety Shut-Off	38.5bar/3850kPa(558psi)			
Recovery Rate (kg/min)		Categorys III	Categorys IV	Categorys V
	Vapor	0.55	0.73	0.72
	Liquid	4.20	5.78	7.63
	Push/pull	8.10	9.00	9.90
Operating Temperature	0 °C - 40 °C			
Dimensions	410×275×300 mm			
Weight	19 kg			

VML-1

Leak Detector

With semiconductor sensor, it is precise and has a long service life. Equipped with a high-performance, rechargeable lithium battery, it is easy to carry and easy to use.

Leading Technology, Superior Quality, Best Experience.

Making Your Job More Enjoyable



Precise Measurement

Ergonomic Design

- Easy to carry

Semiconductor Sensor

- Precise measurement
- Extended service life

External Power Supply

- Extended use

Lithium Battery

- Rechargeable

Model	VML-1
Suitable for refrigerant	CFC, HCFC, HFC refrigerant
Minimum of leakage	≤3g/year (R134A)
Response time	≤3s (regarding the size and distance of source of leaks)
Life time of battery	≥8 hours
Pressure of system under test	≥50 kPa
Life time of sensor	≥1 year under normal usage
Power	5V
Calibration	auto
Weight	350 g
Length of probe	40 cm

VRM2-0101i

Digital Manifold Gauge



VRM2-B-0401

Manifold Gauge



Precision / Impact-Resistant

Accurate

- Precision pressure gauge with Class 0.4 accuracy

Ball Valve Handle

- Efficient, convenient, easy
- Better work experience

Impact-Resistant

- Impact-resistant design
- Durable rubber cover

Folding Hook

- Hidden hook design, easy to transport

Digital Display

- Easy to read

Model	VRM2-0101i
Refrigerants	R22, R134a, R1234yf, R290, R404A, R407C, R410A, R32, R507
Pressure Scale	-30 inHg~720 psi
Hose	Red 1/4"-5/16"; Yellow 1/4"-1/4"; Blue 1/4"-5/16" With 2 pcs adapters: Male: 5/16" SAE Female: 1/4" SAE
Standard Length	3x150 cm
Package	Blow Case

NOTICE: All information listed above is standard type, if you have other requirement, please appoint in the order.

Precision / Impact-Resistant

Accurate

- Precision pressure gauge with Class 1.0 accuracy

Ball Valve Handle

- Efficient, convenient, easy
- Better work experience

Impact-Resistant

- Impact-resistant design
- Durable rubber cover

Folding Hook

- Hidden hook design, easy to transport

Model	VRM2-B-0401	VRM2-B-0501
Refrigerants	R22, R134a, R410A, R407C	R22, R134a, R404A, R407C
Gauge Diameter	Φ68 mm	Φ68 mm
Pressure Scale	-30 inHg ~ 800 psi; -30 inHg ~ 550 psi	-30 inHg ~ 400 psi; -30 inHg ~ 350 psi
Hose	Red 1/4"-5/16"; Yellow 1/4"-1/4"; Blue 1/4"-5/16" With 2 pcs adapters: Male: 5/16" SAE Female: 1/4" SAE	Red 1/4"-1/4"; Yellow 1/4"-1/4"; Blue 1/4"-1/4"
Standard Length	3x150 cm	3x150 cm
Package	Blow Case	Blow Case

NOTICE: All information listed above is standard type, if you have other requirement, please appoint in the order.

VRM1-0101i

Digital Manifold Gauge



VRM1-B-0403

Manifold Gauge



Precision / Impact-Resistant

Accurate

- Precision pressure gauge with Class 0.4 accuracy

Ball Valve Handle

- Efficient, convenient, easy
- Better work experience

Impact-Resistant

- Impact-resistant design
- Durable rubber cover

Folding Hook

- Hidden hook design, easy to transport

Digital Display

- Easy to read

Model	VRM1-0101i
Refrigerants	R22, R134a, R1234yf, R290, R404A, R407C, R410A, R32, R507
Pressure Scale	-30 inHg~720 psi
Hose	Red 1/4"-5/16" ; Yellow 1/4"-1/4" With 1 pc adapter: Male: 5/16" SAE Female: 1/4" SAE
Standard Length	2x150 cm
Package	Blow Case

NOTICE: All information listed above is standard type, if you have other requirement, please appoint in the order.

Precision / Impact-Resistant

Accurate

- Precision pressure gauge with Class 1.0 accuracy

Ball Valve Handle

- Efficient, convenient, easy
- Better work experience

Impact-Resistant

- Impact-resistant design
- Durable rubber cover

Folding Hook

- Hidden hook design, easy to transport

Model	VRM1-B-0403	VRM1-B-0404
Refrigerants	R22, R134a, R410A, R407C	R22, R134a, R410A, R407C
Gauge Diameter	Φ68 mm	Φ68 mm
Pressure Scale	-30 inHg ~ 800 psi;	-30 inHg ~ 550 psi;
Package	Blister packing	Blister packing

NOTICE: All information listed above is standard type, if you have other requirement, please appoint in the order.

Wireless Refrigerant Scale



Magnesium Alloy Weighing Pan

Large Screen Backlight Electronic Display

Wireless Bluetooth Control

Lighter

Other Branded Products

VRS-100-01

Wireless Refrigerant Scale

Suitable for larger size refrigerant cylinders



Aluminium Weighing Pan

Large Screen Backlight Electronic Display

Wireless Bluetooth Control

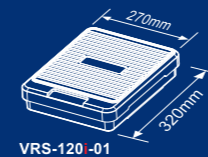

VRS-120-01

Other Branded Products

Larger Size Weighing Pan

Precise Charging

Wireless Bluetooth Control

- More convenient

Precision Sensor

- Precision measurement
- Accuracy 0.05%

Magnesium alloy weighing pan

- Only 2.0Kg, easy to carry

Large Backlit Display

- Large screen data display, better readability

Integrated Handle Design

Model	VRS-50-01	VRS-100-01
Weighting range	50 kg	100 kg
Resolution	2 g	5 g
Accuracy	0.05%	0.05%
Power	4xAA, 4xAAA	4xAA, 4xAAA
Dimensions	210x260 mm	210x260 mm
Weight	2.0 kg	2.0 kg

Precise Charging

Wireless Bluetooth Control

- More convenient

Precision Sensor

- Precision measurement
- Accuracy 0.05%

Larger Size Weighing Pan

- Suitable for larger size refrigerant cylinders

Aluminium Weighing Pan

- High strength, High reliability
- More durable

Large Backlit Display

- Large screen data display, better readability

Integrated Handle Design

Model	VRS-60-01	VRS-120-01
Weighting range	60 kg	120 kg
Resolution	5 g	10 g
Accuracy	0.05%	0.05%
Power	4xAA, 4xAAA	4xAA, 4xAAA
Dimensions	320x270 mm	320x270 mm
Weight	4.7 kg	4.7 kg

